

EASY-IN POOL STEP SYSTEM

NE132



This instruction manual features multiple guides for the step unit components.

EASY POOL STEP — (NE113)

FOR USE WITH:



EASY-IN POOL STEP

PARTS & HARDWARE FOR STEP



A. LONG HANDRAIL POST (2)
(NEP2120)



B. SHORT HANDRAIL POST (2)
(NEP2107)



C. STEPS (4)
(NEP2018)



D. RISERS (4)
(NEP2016)



E. BASES (2)
(NEP2010)



F. MOUNTING BRACKETS (2)
(NEP2015)

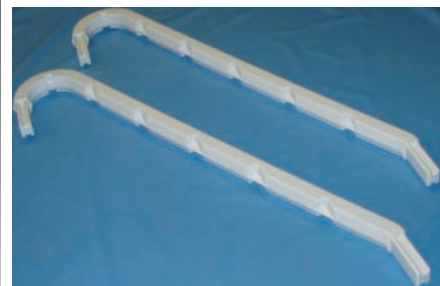

G. HANDRAILS (2)
(NEP2012)

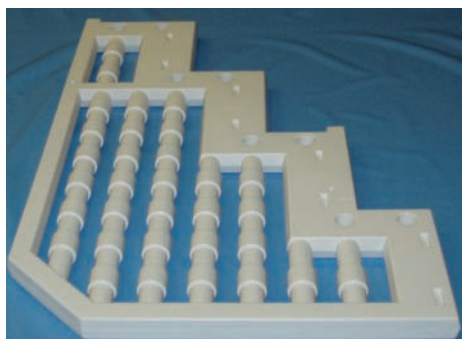

H. SIDE PANELS (2)
(AC PANELS)



I. LOCK CAPS (16)
(NEP2014)

J. HARDWARE

(NEP2013)

- 14 - 1-1/4" screws



K. DANGER STICKERS
(NEP2011)

STEP 1

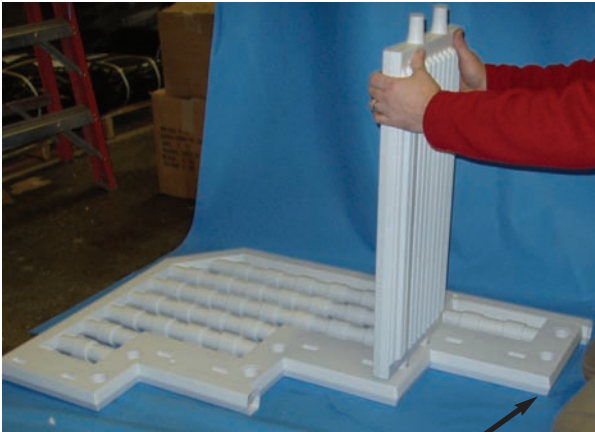

TOP OF PANEL

- Lay one of the side panels (**H**) down on a flat surface.
- Each step (**C**) has a groove where the riser will slide in which is located on the bottom of each step.
- Line up a step (**C**) by positioning the connected dowels on the step with two of the round holes on the side panel (**H**). **NOTE:** Make sure that the treads on the step are facing towards the TOP of the side panel (the skinnier part of panel) and that the riser groove on the step is towards the back of the step.
- Push the step until it clicks in place. Repeat for each of the three remaining steps (**C**). If necessary, you may use the rubber mallet or hammer with wood on top to tap into place.

STEP 2

- Insert a riser (**D**) between each of the steps. Locate the hole in the center of the riser. This hole should face towards the back of the side panel.
- The riser should slide right into the grooves on the steps and the square notches should fit right into the recessed openings on the panel.
- Repeat for each of the three remaining risers.

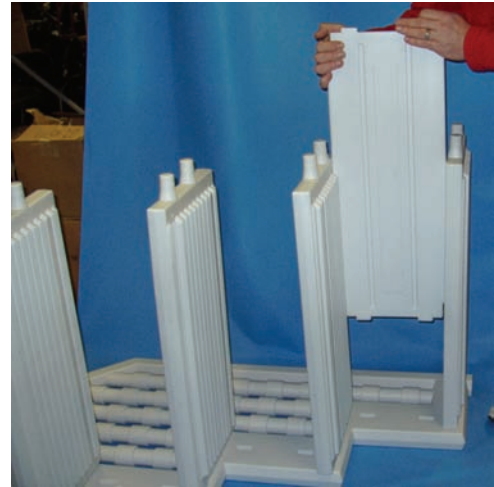

STEP 3



- Once all risers are in place, line up second side panel with the connected dowels on installed steps.
- Push down on side panel to lock in place, if necessary use rubber mallet or (hammer with piece of wood) to fully seat side panel.

STEP 4



- Leave the side panel facing upward and position one of the lock caps **(I)** centered over any hole on the side panel.
- Using a small rubber mallet or a (block of wood and a small hammer), tap on the locking cap until it is secured over the pin sticking through the side of the step and is flush with the side panel.
- Repeat this procedure for each of the additional seven openings on this side of the step.
- Flip step so that other side panel is facing upwards and repeat above for the eight holes on this side.

STEP 5

- Leave the side panel facing upward and position one of the bases **(E)** under the side panel with the channel against the step.



- Secure the base to the side panel with two zip ties. There is a molded groove in the base for placement of the zip tie. Tighten zip tie securely.
- Repeat for opposite side.



NOTE Zip tie should catch and lock when pulled tight, if it does not then turn the zip tie over and reattach.



NOTE To prevent damage to liner, make sure that the locking tab on zip tie is positioned so that it will NOT come in contact with liner.

STEP 6



- Stand step upright and locate two short handrail posts (**B**).
- The short handrail posts should be installed into the holes located on the second step with closed end inside the hole and the open end facing up.
- Screw handrail posts into place using (2) screws from hardware bag (**J**).



NOTE Do NOT install long handrail posts at this time, they must be installed after completing Step 7.

STEP 7

- Place assembled step INSIDE the pool where you would like to enter the pool. Filter should be switched off to stop water circulation.
 - a. If you have a deck, position step in area where it can be attached to your deck.
 - b. If you have the Easy Step without ladder or Easy Pool Step Entry System position step where you would like to enter the pool.



NOTE When installing a step inside of your pool it is recommended to install a step mat underneath to protect your liner. This item is sold separately.

Place funnel up here and pour sand through these posts

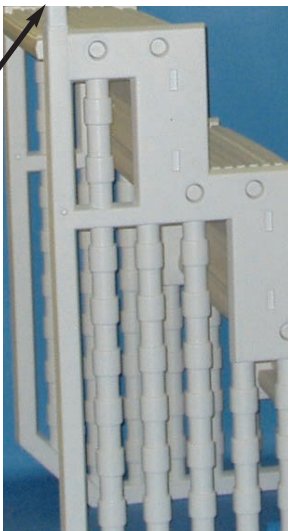

- Once step is placed in pool, tip the step forward and move it left and right to ensure that air escapes and water enters the steps and risers. This will help keep the step stationary in the pool.
- In order for step to sit properly, it must be weighted in place using approximately 40 lbs of sand. To weight step, place funnel in opening of side panel on top step that is now inside pool. Pour 20 lbs of sand into EACH side of the step.



NOTE You may need to rock the step back and forth a little to distribute the sand so the 20 lbs will fit in each side of the step.

STEP 8

- The two long handrail posts (**A**) should be installed into the holes located at the back of the step.
- When installing these posts, make sure that the closed end goes into the opening and that the open end is facing up.
- Once in place, secure using (2) screws from hardware bag (**J**).

NOTE If you are having a problem getting the handrail posts in due to the sand, rock the step left and right to distribute sand.



****IF YOU ARE INSTALLING THE EASY POOL STEP WITH OUTSIDE LADDER, PLEASE REFER TO NE126B OUTSIDE LADDER INSTRUCTIONS AT THIS TIME.**

****IF YOU ARE INSTALLING THE EASY POOL STEP ENTRY SYSTEM, PLEASE REFER TO NB138B CROSSOVER INSTRUCTIONS AT THIS TIME.**

STEP 9



- If you are reading this step, then you will be attaching this staircase to an existing deck at the pool site. If you are NOT installing this step to a deck, please refer to the above notes for your next step.
 - Locate mounting brackets (**F**) and slide one over each of the long handrail posts. These will be used to secure your step to your decking.
 - Adjust mounting brackets height-wise so that they are even with your deck. Once these are even, make sure step is where you would like it in pool. Make sure the upright posts are as close as possible to pool top rails.
- Attach mounting brackets by screwing into deck through two of the three holes on each mounting bracket (choose the openings that best fits your deck). The screws necessary for attachment are NOT included as there are several types of deck materials and the necessary screws will vary.

NOTE Step **MUST** be secured to deck to prevent rocking or tipping. If the mounting brackets do not reach the deck, you will need to extend that part of the deck surface so that the brackets can be screwed in place.

STEP 10



- Lubricate inside of long and short handrail posts with liquid soap or lubricant.
- Attach handrails (**D**) to handrail posts by pushing into posts. The more curved part of the handrail is meant to be installed in the long handrail post.
- Using (4) screws from hardware bag (**J**), secure handrails in place.
- Stick one danger sticker (**K**) on each handrail so that one faces inside the pool and the other faces the outside.

SAFETY INFORMATION

- When lifting heavy or awkward loads, it is suggested that two people lift to avoid injury.
- **DO NOT** use the pool steps for any purpose other than that for which it is intended.
- Maximum weight on steps should **NOT** exceed 350 lbs.



WARNING Exceeding the recommended weight limit may cause the step to fail and may result in injury.

MAINTENANCE

- Step/ladder/bridges must be removed for winter, failure to do so can cause the step to crack.
- When removing step/ladder/bridges for winter, it is recommended that you spray down step with hose water to rinse off any chemical residual prior to storing.
- When storing step/ladder/bridges for winter, it should be protected from the elements and stored either in a shed or garage, or covered with a tarp.

HEAVY DUTY IN-POOL LADDER NE1175



TOOLS REQUIRED

- Drill with 1/8" drill bit
- Small rubber mallet or hammer w/piece of wood
- Phillips head screwdriver
- Pliers
- Spray lubricant or liquid soap
- 40 Lbs. of Sand
- Funnel
- Hacksaw

PARTS & HARDWARE FOR STEP

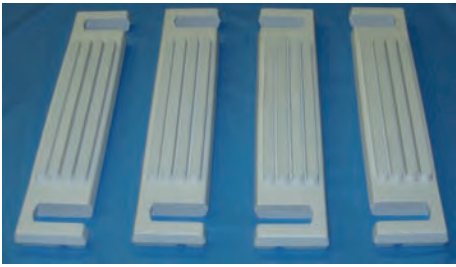

A. UPPER STEP (4)
(NEP2028)



B. MOUNTING BLOCKS (2)
(NEP2023)



C. ADJUSTABLE TUBE (2)
(NEP2177)



D. HANDRAIL
(2)
(NEP6369)



E. LEG (2)
(NEP2178)

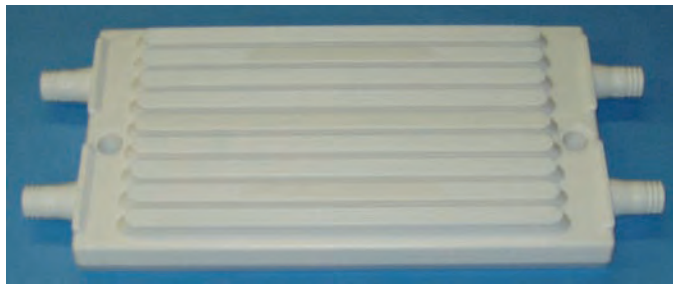

F. PLATFORM
(NEP2025)



G. BOTTOM STEP
(NEP2020)



H. HARDWARE
(NEP2173)



I. SHIELD
(NEP2027)



J. LOCKING CAP (4)
(NEP2014)



K. LARGE BARRIER
(NEP2172)



L. SMALL BARRIER
(NEP2173)

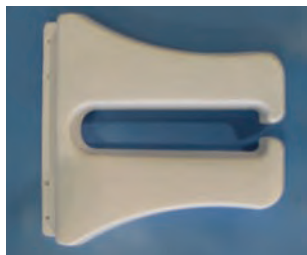

M. UPPER BRACE
(NEP2174)

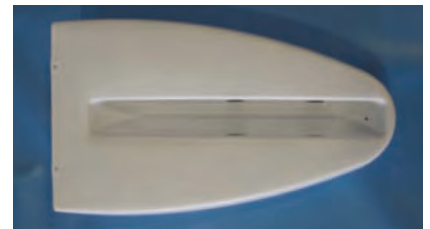

N. LOWER BASE
(NEP2175)

STEP 1



- Place the bottom step (**G**) on a level surface with indentations facing up.
- Take leg (**E**) and stand upright (pointed side down). When installed on bottom step, the leg will need to have the raised areas facing inward. The raised area with the pre-drilled screw hole should be at the front of the ladder toward the top of the leg.
- Place the left leg into the indentation on the left side of the step and push straight down until it clicks into place.
- Repeat above for right leg on right side of step.

STEP 2

- There are two sets of lug locations on the stringers in the areas where each step will be installed. Each step should be installed into the UPPER set of lugs only.
- Locate one of the four groups of lugs and slide step (**A**) into the upper set of lugs on the legs so it clicks into place.
- Repeat for each of the remaining (3) steps.
- Secure all by drilling (1) 10 x 1-1/4" screw into each side of the step through the pre-marked leg openings.

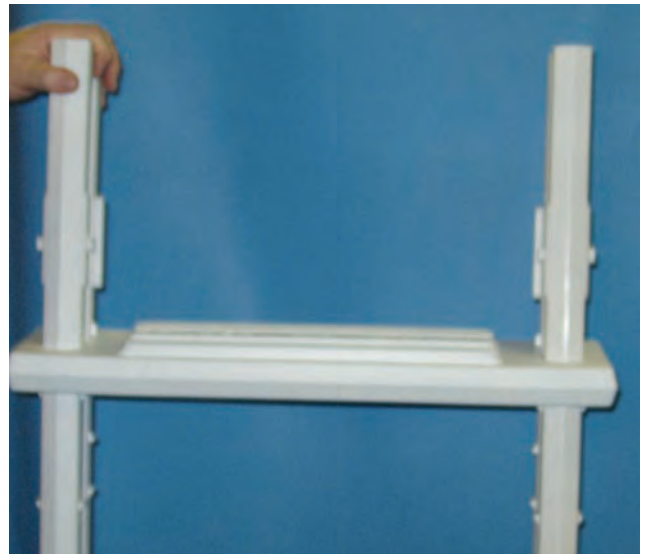

STEP 3



- Place the Lower Base (**N**) on a level surface.
- Snap Large Barrier (**K**) into the groove on the lower base facing round edge.
- Snap Small Barrier (**L**) into the groove on the lower base facing the straight side.

- Slide Upper Brace (**M**) over Small Barrier as shown.



- Slide Upper Brace (**M**) through the groove in the Large Barrier and push down lightly to secure.

- Screw Lower Base of Entrapment Barrier into bottom step of the Inside Portion of the Ladder with (2) 10 x 1-1/4" screws.



STEP 3 CONT.



- Screw Upper Brace of Entrapment Barrier into the third step of the Inside Portion of the Ladder with (2) 10 x 1-1/4" screws

STEP 4

NOTE Only follow this step if using as an In Pool Ladder

- This Ladder is designed to fit multiple pool heights. **ONLY FOLLOW THIS STEP IF YOUR POOL HEIGHT IS 48"**.
- Locate the leg (E) on both sides of the ladder.
- Find the lines located at the top of the legs.
- Using a hacksaw cut both legs evenly along the line.



FOR 48" POOLS, CUT ALL FOUR LEGS AT THIS LINE

STEP 5



FILL LEGS WITH SAND USING A FUNNEL

- Using a funnel fill both legs with sand. Use approximately 20 Lbs. of sand in each leg.

STEP 6



- Put ladder aside for now and install handrails (**D**) onto platform (**F**).
- Lay one handrail on at surface and push the connected dowels of the platform into the openings on the handrail until fully seated. Make sure treads of platform are facing upward.
- Before attaching second handrail, make sure that the longer part of the handrail is facing in the same direction on both handrails. Repeat above for installation of second handrail.

- Center locking cap (**J**) over opening on side of handrail where platform was just attached. Using a rubber mallet or a hammer and a small piece of wood, tap on cap until the cap is flush with the handrail
- Repeat for each of the remaining (3) locking caps.
- Coat the tops of the legs with lubricant and attach handrails by pushing them down over the legs. Secure with (4) #10 1-1/4" screws through each of the pre-marked openings.



- NOTE**
- If attaching to a Deck proceed to STEP 7
 - If attaching to a Step to create the Entry System proceed to STEP 8

STEP 7—DECK MOUNT

- Coat adjustable tube (**C**) with lubricant and slip (1) mounting block (**B**) all the way down over the nubs on the tube. The open side should be exposed.
- Repeat for second adjustable tube and mounting block.
- Push one adjustable tube into the longer part of each handrail. The mounting block should sit on the top step to hold the ladder in place. Secure into handrail using (4) #10 1-1/4" screws in pre-marked openings.
- Move tube down to deck until it rests on the deck. Using the proper hardware (not included) screw mounting blocks into decking through the pre-drilled holes.

STEP 8 — ATLANTIS ENTRY SYSTEM



- To attach the ladder to the step assembly, you will need to attach the shield **(I)**.
- Line the shield up above the handrail and push it down so it slides onto the handrail. Repeat for opposite side.
- Rotate shield 90 degrees, so that the open sleeve of each shield is on the outside (see photo).

STEP 9



- Once shields are situated properly, lift ladder up and line up the openings of shield with long handrail posts of the step.
- Slide the ladder down until it rests on ground outside.

- Coat adjustable tube **(C)** with lubricant and slip (1) mounting block **(B)** all the way down over the nubs on the tube. The open side should be exposed.
- Repeat for second adjustable tube and mounting block.

OPEN
END

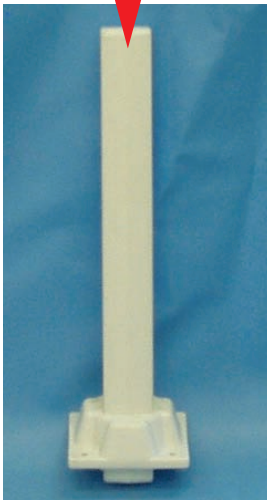

- Push one adjustable tube into the longer part of each handrail. The mounting block should sit on the top step to hold the ladder in place. Secure into handrail using (4) #10 1-1/4" screws in pre-marked openings.
- Secure each mounting block to the top step of the staircase using (4) 10 1-1/4" screws per mounting block.
- Fasten the shields to the handrails using (8) #10 1-1/4" screws (4 per side).

STEP 10



- Lubricate inside of long and short handrail posts on step with liquid soap or lubricant.
- Attach handrails **(D)** from step box to handrail posts by pushing into posts. The more curved part of the handrail is meant to be installed in the long handrail post.
- Using (4) screws from step box hardware bag **(J)**, secure handrails in place.



NOTE If attaching Gate System. Please refer to instructions packed in carton marked AC 30988

SAFETY INFORMATION

- When lifting heavy or awkward loads, it is suggested that two people lift to avoid injury.
- **DO NOT** use the pool entry system for any purpose other than that for which it is intended.
- Maximum weight on steps should **NOT** exceed 350 lbs.



WARNING Exceeding the recommended weight limit may cause the step to fail and may result in injury.

MAINTENANCE

- Step/ladder/bridges must be removed for winter, failure to do so can cause the step to crack.
- When removing step/ladder/bridges for winter, it is recommended that you spray down step with hose water to rinse off any chemical residual prior to storing.
- When storing step/ladder/bridges for winter, they should be protected from the elements and stored either in a shed or garage, or covered with a tarp.

PICKET INSTALLATION



- Align one of the triple pickets (**E**) with the notches at the top of the handrail of the OUTSIDE step. The triple picket will line up with the openings in the handrail on the top step.
- The double picket (**D**) will fit on the second step down (shown).
- The single picket (**C**) will be attached to the handrail on the third step down.
- Fasten the pickets in place one at a time at the top and bottom using the #10 x 3/4" screws (**H**).

UNIVERSAL GATE SYSTEM

NE138C

FOR USE WITH



NE132

TOOLS REQUIRED

- Phillips head screwdriver
- Drill with 1/16" drill bit

This gate is the final component of NE138 and NE132.
Prior to installing the gate, please follow the instructions included in the other cartons

NOTE If you are adding this component after completing the full step assembly (NE113), you will need to remove the outside handrails to install the gate.

UNIVERSAL GATE SYSTEM PARTS

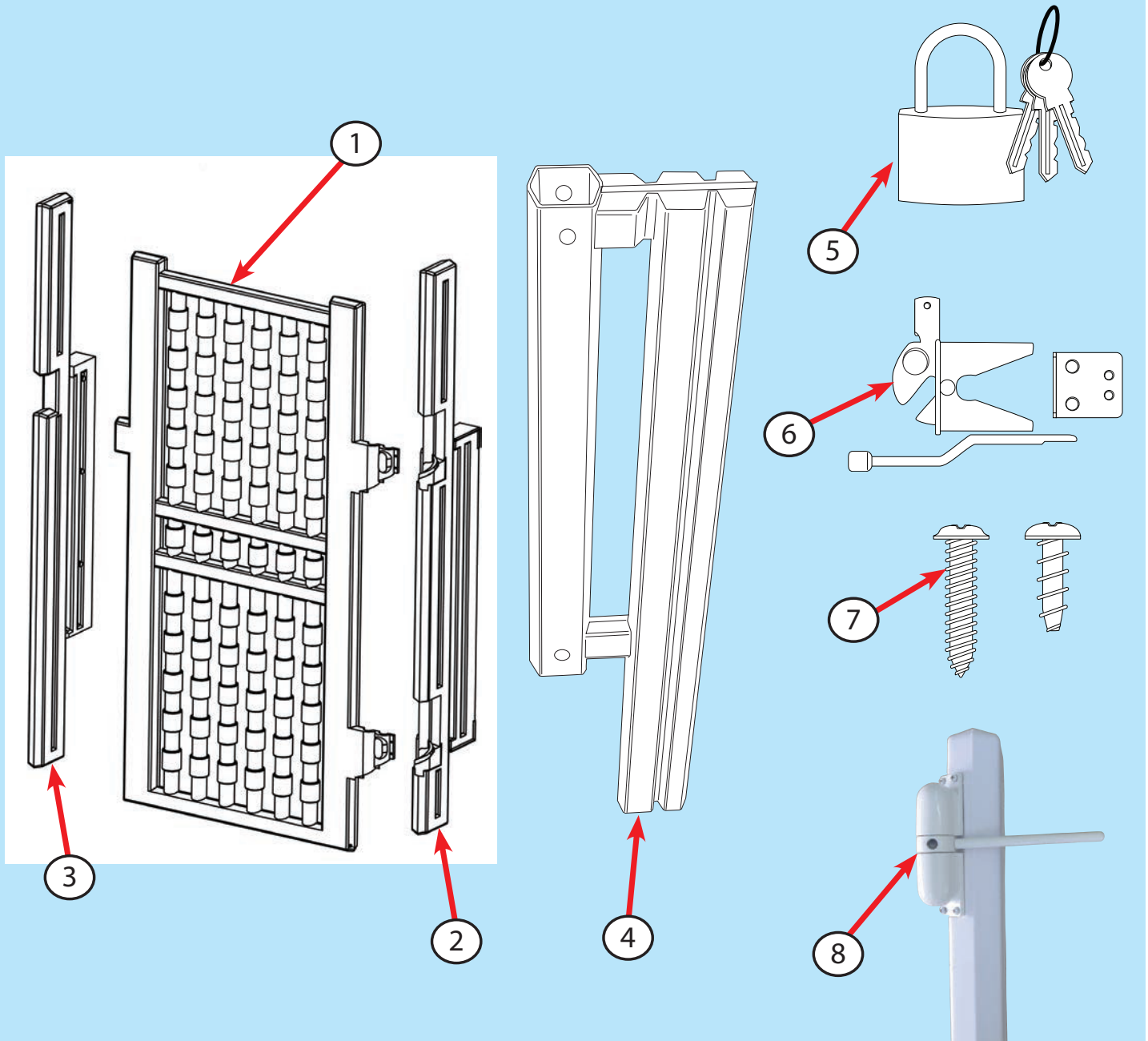

PART	MODEL #	REORDER #	DESCRIPTION	QTY
1	AC GATE	NEP2041	Gate	1
2	AC HINGEPT	NEP2038	Hinge Post	1
3	AC LATCHPT	NEP2039	Latch Post	1
4	AC HINGEMT	NEP2037	Mounting Post	2
5	AC PADLOCK	NEP2190	Padlock	1
6	AC GATELATH	NEP2035	Gate Latch Assembly	1
7	AC HDW30988	NEP2118	Hardware Bag	1
8	AC 79073	NEP2191	Optional Gate Closer	1

STEP 1

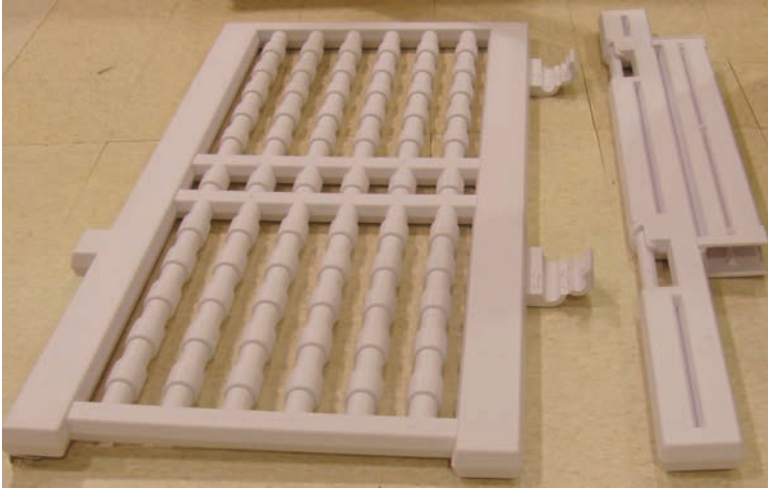

- Lay gate (**AC GATE**) flat on a clean, level area and open plastic hinges as shown.

- Locate hinge post (**AC HINGEPT**) and lay next to gate with openings lined up to plastic hinges of gate.
- Stick plastic hinges of gate through openings of hinge post. The wider part of the hinge post is the bottom and should be lined up with the bottom of the gate (flat part indicates bottom).

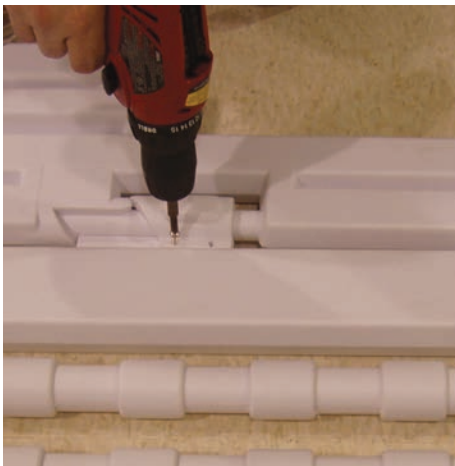
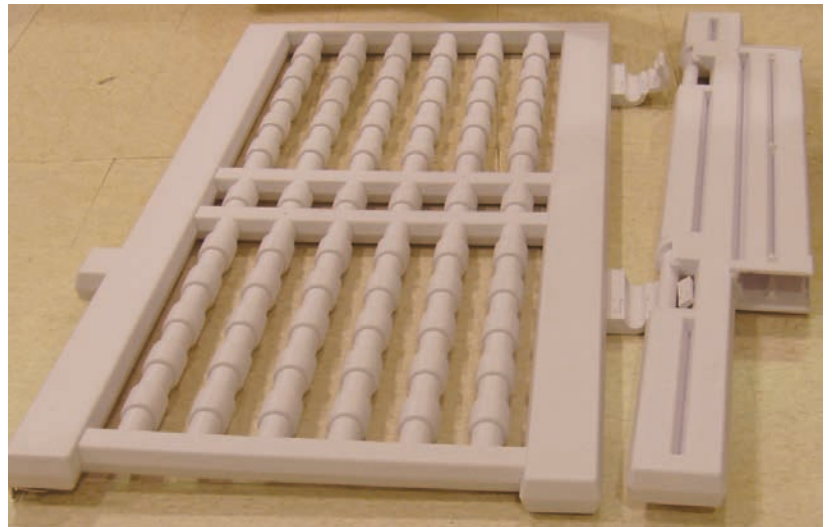

- Wrap plastic hinges around hinge post and secure in place using (8) of the #7 x 1/2" screws from hardware (**AC HDW30988**).

STEP 2



- The hinge mounting posts (**AC HINGEMT**) should be installed onto the short handrail posts on the second step of the outside staircase.
- Attach one hinge mounting post to each of the short handrail posts with the long skinny side facing down towards the step.
- Secure in place using (4) of the # 10 x 1-1/4" screws from hardware (**AC HDW30988**) through pre-marked openings.

STEP 3



- Slide hinge post with attached gate **OVER** hinge mounting post (**AC HINGEMT**) on right side of step. Make sure that post is pushed on completely and that post touches bottom step of staircase. Note: *It may be necessary to spread the back of the hinge post open to install.*
- Fasten hinge post to mounting post using (6) of the #10 x 1-1/4" screws found in hardware bag (**AC HDW30988**) through pre-marked openings on inside and outside of post.

STEP 4



- Slide latch mounting post (**AC LATCHPT**) onto hinge mounting post (**AC HINGEMT**) on left side of step.
NOTE: It may be necessary to spread the back of the latch mounting post open to install.

NOTE Picture here shows view from **BEHIND** step, the latch mounting post should face the same way as the hinge post.

- The door stop (squared piece sticking out on gate) should sit perfectly in recessed area of latch mounting post (**AC LATCHPT**). If it is **NOT** sitting correctly, adjust the height of the latch mounting post until it sits flush. Once in place, secure post to mounting post using (6) of the #10 x 1-1/4" screws through pre-marked openings.



NOTE Do not install gate latch assembly until the gate is seated properly otherwise the latch will not catch.

STEP 5

- To complete installation, you will need the gate latch assembly (**AC GATELATH**).
- There is a raised area of the latch mounting post where you will secure the latch itself using the (4) short screws supplied with the latch.
- Secure bar to either of the far openings on the plate. Make sure bar lines up with latch so it will close properly.
- Using two remaining short screws, secure plate to the corner of the gate through two holes closest to the latch.



STEP 6 - OPTIONAL GATE CLOSER — AC 79073

- The optional gate closer is designed to assist the gravity close feature of your Bridge Entry System.

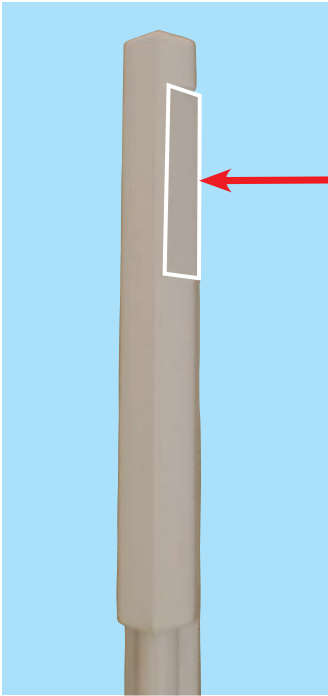

- The gate closer is to be installed on the hinge post in the space provided.
- Mount the closer onto the hinged post on the flat area of the post above the 2 hinges.

- Secure the closer to the hinge post with the screws provided with the closer.



- The arm of the closer must face the latch side of the gate for the closer to function.

NOTE Lubrication of the self closer with a silicone based lubricant will enhance the closers performance.

HOW TO SET TENSION



- Turn the center hole away from the door with the steel bar supplied.

- Screw the arm into the hole nearest the gate.



- Remove the steel bar and allow arm to close.

- To increase or decrease the tension, repeat the above steps one hole at a time until the desired tension is found.



WARNING Do not over tension the closer. Over tensioning will cause the spring to buckle and the gate to slam shut and could cause damage.

SAFETY INFORMATION

- When lifting heavy or awkward loads, it is suggested that two people lift to avoid injury.
- **DO NOT** use the pool entry system for any purpose other than that for which it is intended.
- Maximum weight on steps should **NOT** exceed 350 lbs.

MAINTENANCE

- Step/ladder/bridges must be removed for winter, failure to do so can cause the step to crack.
- When removing step/ladder/bridges for winter, it is recommended that you spray down step with hose water to rinse off any chemical residual prior to storing.
- When storing step/ladder/bridges for winter, it should be protected from the elements and stored either in a shed or garage, or covered with a tarp.