



*Designed for Fun, Built to Last™*

# BRIDGEPORT 2-IN-1 POKER TABLE SET ASSEMBLY INSTRUCTIONS



**Please Do Not Hesitate to  
Contact Our Consumer Hotline  
at 800-759-0977  
with Any Questions That May  
Arise During Assembly or  
Use of This Product!**

# THANK YOU!

**Thank you for purchasing this product.** We work around the clock and around the globe to ensure that our products maintain the highest possible quality. However, in the rare case of issues during assembly or use of this product, please contact our Consumer Hotline at **800-759-0977** for immediate assistance before contacting your retailer. Please read the warranty information at the back of these assembly instructions for further details.

## ASSEMBLY TIPS

### IMPORTANT! PLEASE READ THESE ASSEMBLY INSTRUCTIONS IN ENTIRETY BEFORE ASSEMBLING YOUR PRODUCT.

1. Find a clean, level surface to begin the assembly of your item. We recommend that two adults work together to assemble this set. You may want to carefully cut or tear the four corners of the box so that the bottom of the box can be used as your work surface.
2. Remove all of the contents from box and verify that you have all of the parts shown on the Parts List before you begin assembly. **Note: Some parts may be pre-installed or pre-assembled.**
3. Some figures or drawings may not look exactly like product.
4. **When installing parts that have more than one screw or bolt, hand tighten all screws or bolts in place before final tightening with screwdriver or wrench.**
5. Electric screwdrivers may be helpful during assembly; however, please set a **low torque** and use extreme caution because screws may be stripped or overtightened, resulting in damaged parts, if the electric screwdriver's torque is set too high.











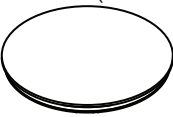

## CARE AND USE

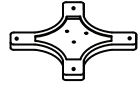
1. This product is intended for **INDOOR** use only.
2. Do **NOT** drag the table or chairs when moving them, as this will damage the legs.

# PARTS IDENTIFIER (NOT TO SCALE)



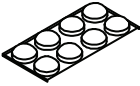







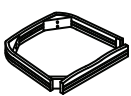

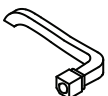
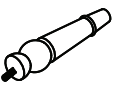

## TABLE

1 NGP6110 (M or W)*  x1 Table Body	2 NGP6111 (M or W)*  x1 Table Top	3 NGP6112 (M or W)*  x1 Pedestal	4 NGP6113 (M or W)*  x4 Foot
5 NGP6114  x1 Plate	6 NGP6115 (M or W)*  x1 Bottom Leg	7 NGP6116**  x7 Bolt	8 NGP6116**  x3 Bolt
9 NGP6116**  x7 Flat Washer	10 NGP6116**  x7 Spring Washer	11 NGP6116**  x1 Allen Wrench	12 NGP6297  x8 Protective Bumper

\*Use M (mahogany) or W (walnut) after part number to specify your wood color. 5/18

\*\*Items included in Hardware Pack, NGP6116

## CHAIR

1 NGP6117 (M or W)*  x1 Chair Back	2 NGP6118 (M or W)*  x1 Seat Frame	3 NGP6119 (M or W)*  x1 Left Armrest	4 NGP6120 (M or W)*  x1 Right Armrest
5 NGP6121 (M or W)*  x2 Leg	6 NGP6122  x1 Seat Cushion	7 NGP6123**  x4 Bolt	8 NGP6123**  x4 Bolt
9 NGP6123**  x2 Bolt	10 NGP6123**  x1 Bolt	11 NGP6123**  x9 Flat Washer	12 NGP6123**  x9 Spring Washer
13 NGP6123**  x1 Allen Wrench	14 NGP6123**  x2 Wood Dowel	15 NGP6123**  x1 Allen Wrench	16 NGP6124  x4 Caster

\*Use M (mahogany) or W (walnut) after part number to specify your wood color. 5/18

\*\*Items included in Hardware Pack, NGP6123

**For replacement parts please call 800-759-0977.**

# ASSEMBLY INSTRUCTIONS

## TABLE

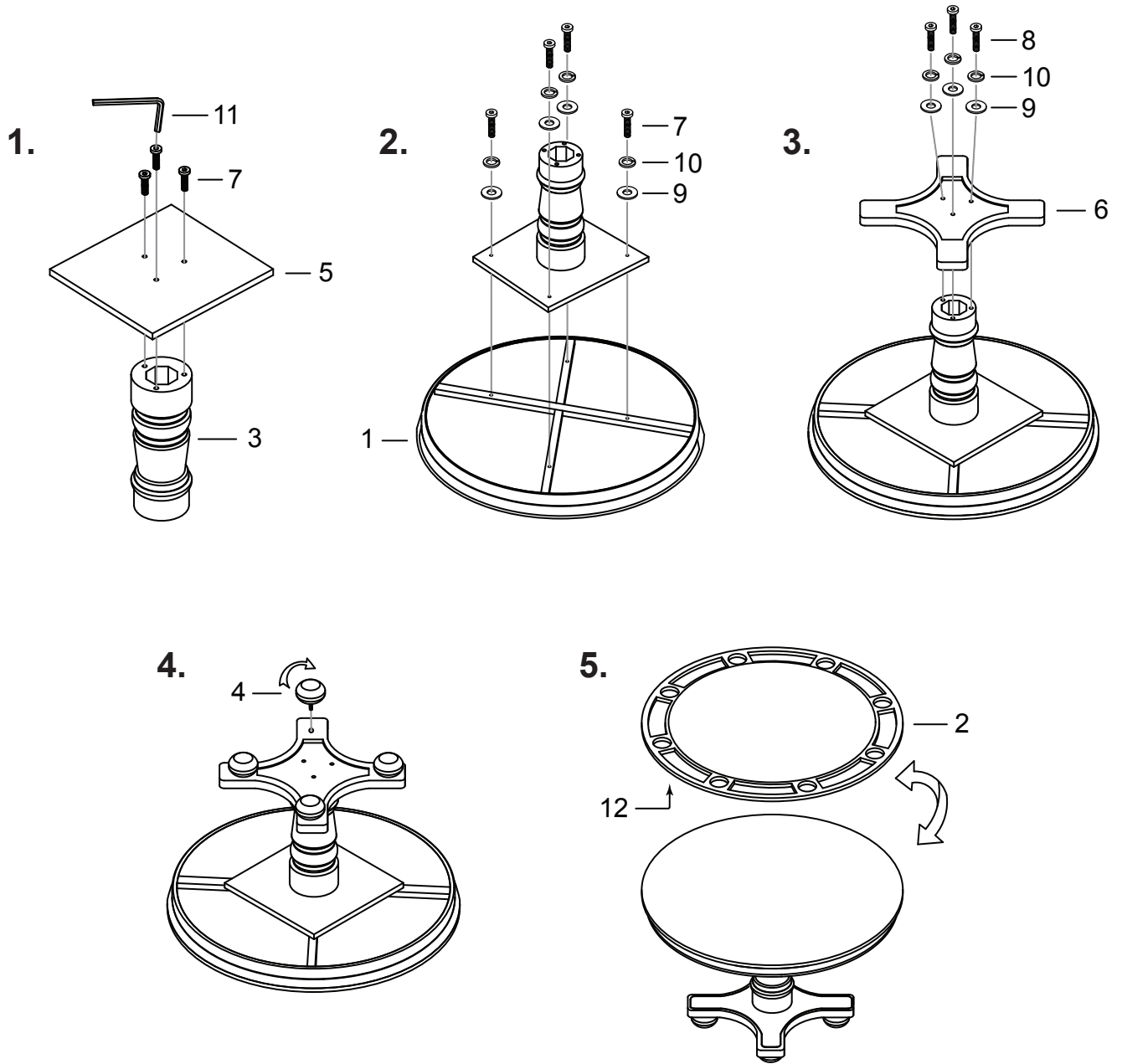

# ASSEMBLY INSTRUCTIONS

## CHAIR

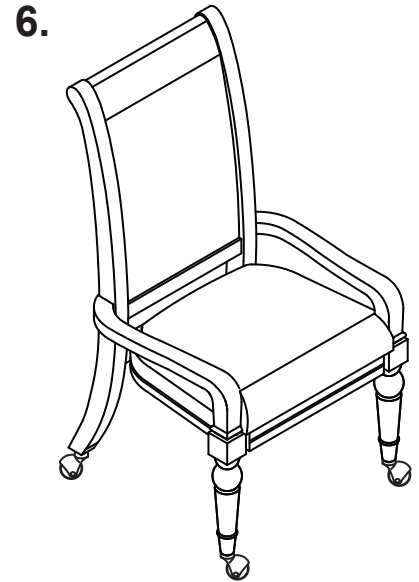
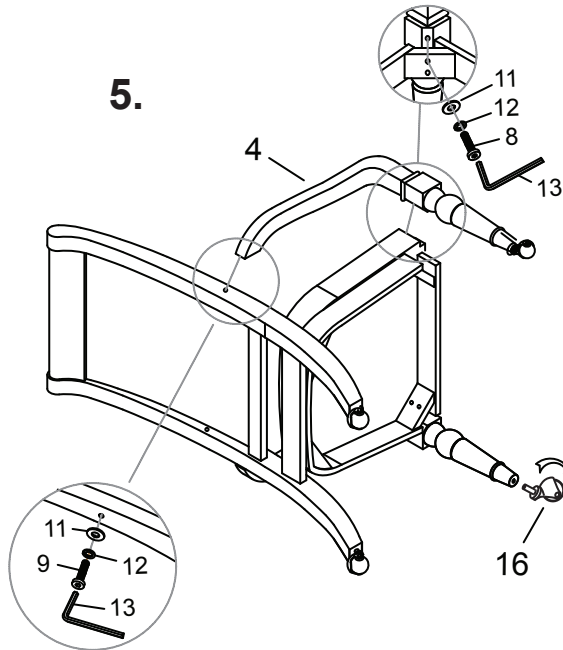
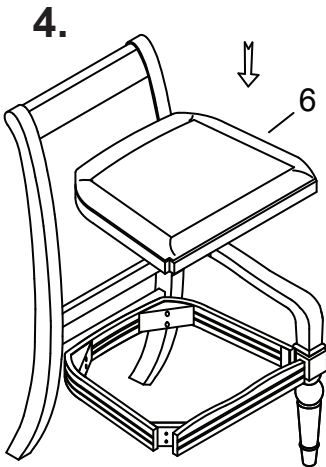
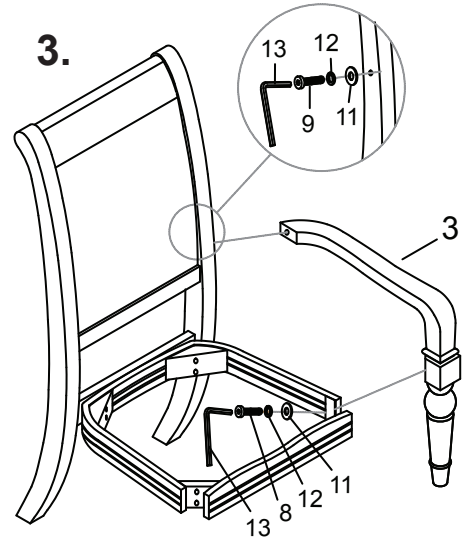
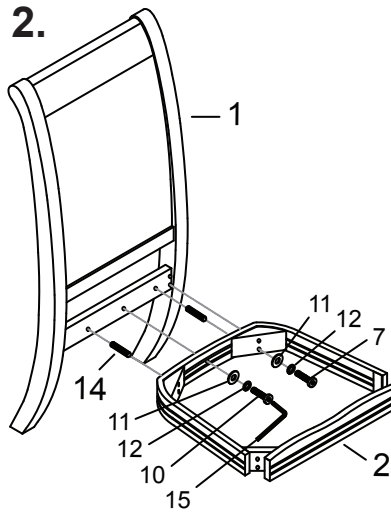
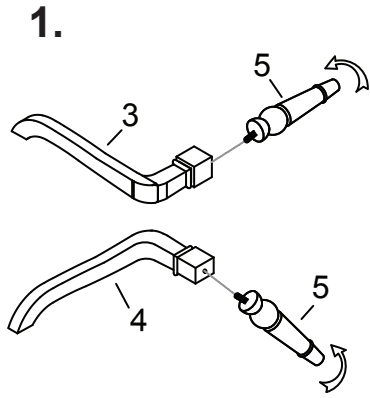

# 180-DAY LIMITED WARRANTY

This product is warranted to the original purchaser to be free from defects in material or workmanship for a period of 180 days from the date of the original retail purchase.

This warranty does not cover defects or damage due to improper installation, alteration, accident or any other event beyond the control of the manufacturer. Defects or damage resulting from misuse, abuse or negligence will void this warranty. This warranty does not cover scratching or damage that may result from normal usage.

This product is not intended for institutional or commercial use; the manufacturer does not assume any liability for such use. Institutional or commercial use will void this warranty.

This warranty is nontransferable and is expressly limited to the repair or replacement of the defective product. During the warranty period, the manufacturer shall repair or replace defective parts at no cost to the purchaser. Shipping charges and insurance are not covered and are the responsibility of the purchaser. Labor charges and related expenses for removal, installation or replacement of the product or components are not covered under this warranty.

The manufacturer reserves the right to make substitutions to warranty claims if parts are unavailable or obsolete.

The manufacturer shall not be liable for loss of use of the product or other consequential or incidental costs, expenses or damages incurred by the consumer of any other use. The user assumes all risk of injury resulting from the use of this product.

This warranty is expressly in lieu of all other warranties, expressed or implied, including warranties of merchantability or fitness for use to the extent permitted by Federal or state law. Neither the manufacturer nor any of its representatives assumes any other liability in connection with this product.

**All warranty claims must be made through the retailer where the product was originally purchased. A purchase receipt or other proof of date of purchase will be required to process all warranty claims. The model number and part numbers found within the assembly instructions will be required when submitting any parts requests or warranty claims.**

**For further warranty information or inquiries, please call 800-759-0977**





*Designed for Fun, Built to Last™*

# TABLE DE POKER 2-en-1 BRIDGEPORT INSTRUCTIONS D'ASSEMBLAGE



Contactez notre  
service à la clientèle au  
**800-759-0977**  
avec des questions sur le montage  
ou l'utilisation de ce produit.

# MERCI!

**Merci d'avoir acheté notre produit.** Nous travaillons 24 heures sur 24, partout dans le monde, à garantir que nos produits sont de la meilleure qualité possible. Toutefois, dans les rares cas de problèmes lors du montage ou de l'utilisation de ce produit, se il vous plaît communiquer avec notre service à la clientèle au **800-759-0977** pour une aide immédiate avant de contacter votre revendeur. Pour obtenir de plus amples renseignements, veuillez lire l'information relative à la garantie au verso de ce guide d'instructions.

## INSTRUCTIONS D'ASSEMBLAGE

### IMPORTANT! VEUILLEZ LIRE, EN ENTIER, TOUTES LES INSTRUCTIONS AVANT D'ASSEMBLER VOTRE PRODUIT.

1. Trouver une surface propre et plane pour commencer l'assemblage de article. Vous pouvez couper ou déchirer soigneusement les quatre coins de la boîte de sorte que le fond de la boîte puisse être utilisé comme surface de travail.
2. Retirez le contenu de la boîte, avant de commencer l'assemblage, assurez-vous d'avoir toutes les pièces telles que listées et illustrées au tableau d'identification. **Avis : certaines pièces sont préassemblées ou préinstallées.**
3. Certaines illustrations ou dessins peuvent ne pas ressembler au produit que vous avez acheté.
4. **Quand vous fixez en place une pièce avec plus d'une vis ou écrou, veuillez, en premier, les visser à la main et terminer la fixation avec un tournevis ou une clé.**
5. Un tournevis électrique peut être utile lors de l'assemblage, mais veuillez le régler à **basse torque** et l'utiliser avec prudence; si la torque est trop élevée, la vis peut se défaire ou être trop serrée.











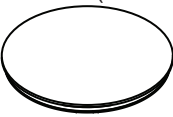

### ENTRETIEN ET USAGE

1. Ce produit doit être utilisé **À L'INTÉRIEUR** seulement.
2. **NE JAMAIS** déplacer la table en la traînant, cela pourrait endommager les pieds.

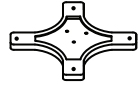

# IDENTIFICATION DES PIÈCES (pas à l'échelle)

## table

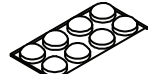









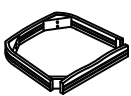

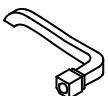

1 NGP6110 (M or W)*  x1 structure principale	2 NGP6111 (M or W)*  x1 dessus de la table	3 NGP6112 (M or W)*  x1 pedestal	4 NGP6113 (M or W)*  x4 pied
5 NGP6114  x1 plaque	6 NGP6115 (M or W)*  x1 bas de la jambe	7 NGP6116**  x7 boulon	8 NGP6116**  x3 boulon
9 NGP6116**  x7 rondelle plate	10 NGP6116**  x7 rondelle fendue	11 NGP6116**  x1 clé allen	12 NGP6297  x8 rasade de protecteur

\*Utilisez M (acajou) ou W (noyer) après le numéro de pièce de spécifier la couleur de votre bois.

\*\*Pièces incluses dans la trousse de quincaillerie, NGP6116

5/18

## chaise

1 NGP6117 (M or W)*  x1 chaise	2 NGP6118 (M or W)*  x1 cadre de siège	3 NGP6119 (M or W)*  x1 accoudoir gauche	4 NGP6120 (M or W)*  x1 accoudoir droit
5 NGP6121 (M or W)*  x2 jambe	6 NGP6122  x1 coussin de siège	7 NGP6123**  x4 boulon	8 NGP6123**  x4 boulon
9 NGP6123**  x2 boulon	10 NGP6123**  x1 boulon	11 NGP6123**  x9 rondelle plate	12 NGP6123**  x9 rondelle fendue
13 NGP6123**  x1 clé allen	14 NGP6123**  x2 goujon de bois	15 NGP6123**  x1 clé allen	16 NGP6124  x4 roulette

\*Utilisez M (acajou) ou W (noyer) après le numéro de pièce de spécifier la couleur de votre bois.

\*\*Pièces incluses dans la trousse de quincaillerie, NGP6123

5/18

**Pour commander les pièces de remplacement, téléphonez au 1 800 759-0977.**

# INSTRUCTIONS D'ASSEMBLAGE

## table

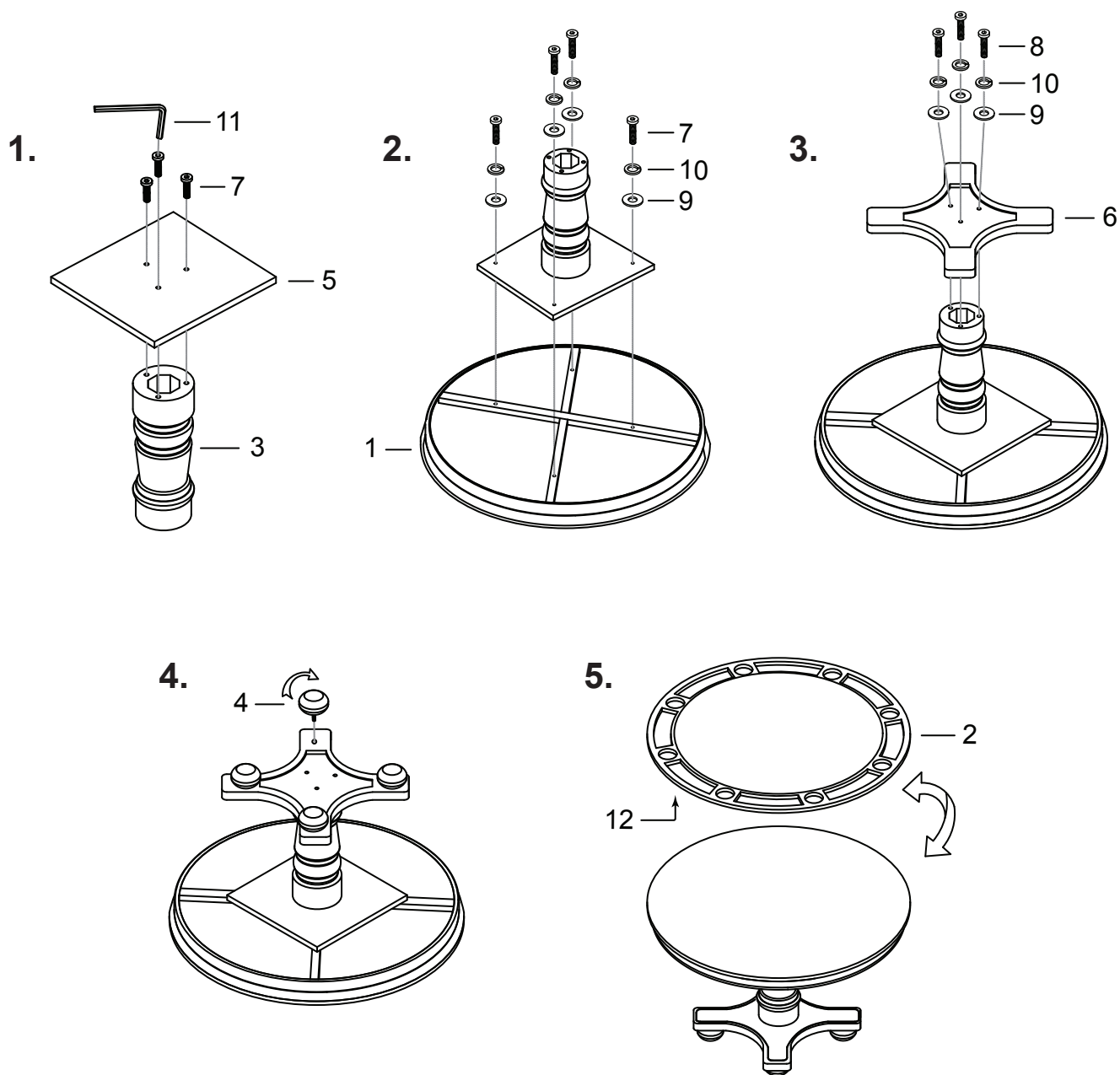

# INSTRUCTIONS D'ASSEMBLAGE

## chaise

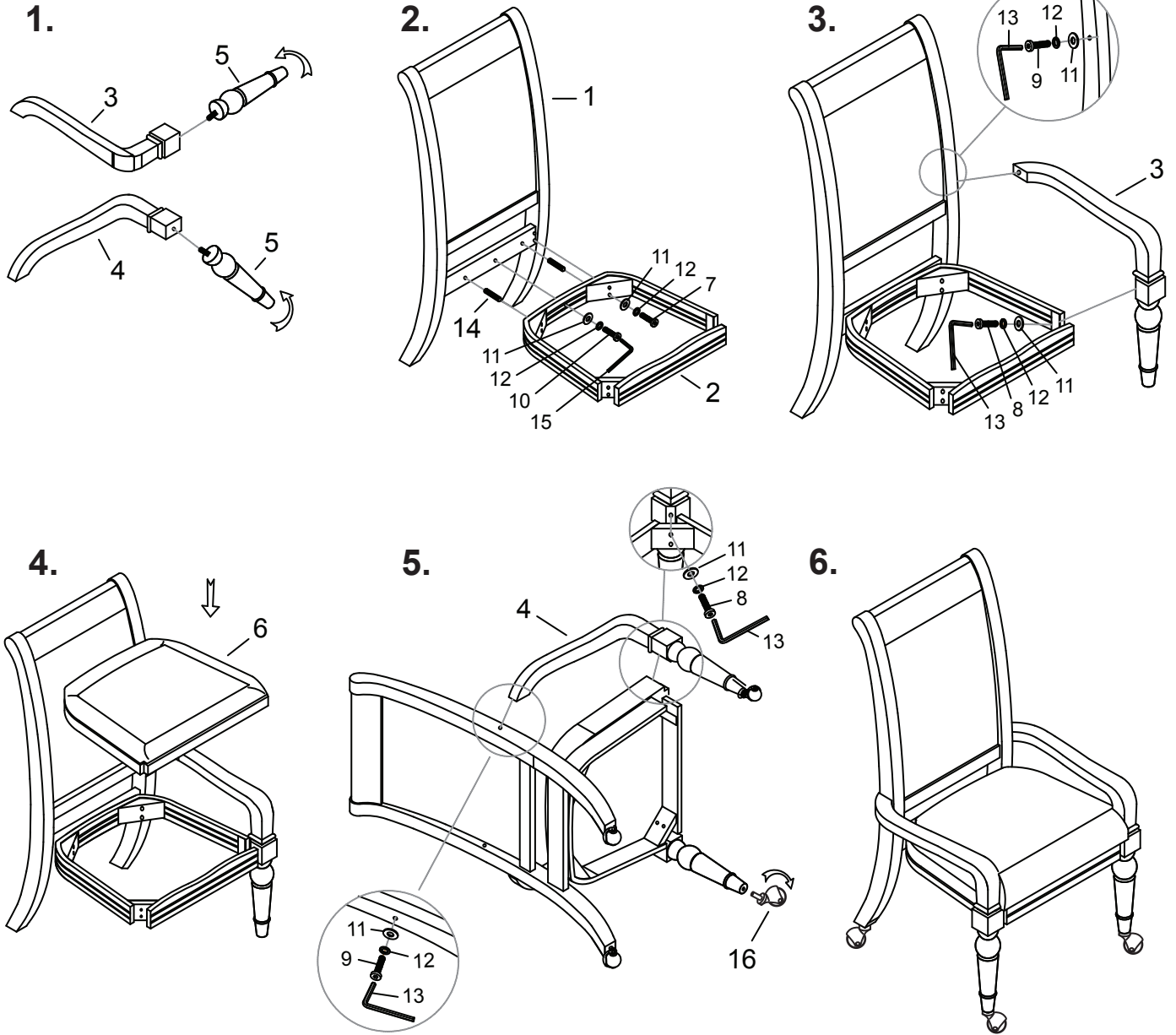

# GARANTIE LIMITÉE DE 180 JOURS

La garantie du produit est valide pour l'acheteur original en ce qui a trait aux pièces défectueuses ou à la main-d'œuvre pour une période de 180 jours de la date d'achat.

Cette garantie n'est couverte pas les dommages causés par accident, par modification, par une installation défectueuse ou tout autre événement hors du contrôle du fabricant. Tout défaut ou dommage résultant de la négligence ou d'une mauvaise utilisation annule cette garantie. La présente garantie ne couvre pas les égratignures ou les dommages attribuables à un usage normal.

Ce produit n'est pas destiné à un usage institutionnel ou commercial; le fabricant décline toute responsabilité pour une telle utilisation. Un usage institutionnel ou commercial annule cette garantie.

Cette garantie est non transférable et est expressément limitée à la réparation ou au remplacement du produit défectueux. Au cours de la période de garantie, le fabricant s'engage à remplacer et à réparer les pièces défectueuses sans frais pour l'acheteur. Les frais d'assurance et d'expédition ne sont pas couverts et sont à la charge de l'acheteur. Les frais de main-d'œuvre et les dépenses liées au déplacement, à l'installation ou au remplacement du produit ou de ses composantes ne sont pas couverts par cette garantie.

Le fabricant se réserve le droit de faire des substitutions de recours en garantie si la pièce n'est pas disponible ou obsolète.

Le fabricant décline toute responsabilité liée à la perte d'utilisation ainsi que tous les autres coûts directs ou indirects, frais ou dommages encourus par le consommateur qui aurait été causés par une autre utilisation. L'utilisateur assume tous les risques de dommage résultant de l'utilisation de ce produit.

Cette garantie tient lieu expressément de toute autre garantie, exprimée ou implicite, y compris les garanties de qualité marchande ou d'adaptation à un emploi particulier dans la mesure permise par les lois fédérales ou provinciales. Ni le fabricant, ni aucun de ses représentants n'assument aucune autre responsabilité en rapport avec ce produit.

**Toute réclamation doit être faite par le détaillant où le produit a été acheté. Une facture ou autre preuve d'achat est nécessaire pour traiter toutes les réclamations de garantie. Le numéro de modèle et les numéros de référence figurant dans les instructions d'assemblage seront exigés lors de la soumission de demande de pièces ou de recours en garantie.**

**Pour plus d'information ou pour toute question, veuillez téléphoner au 1 800 759-0977.**