



Personal Ultrasonic Aroma Diffuser



Model: SA-028

TABLE OF CONTENTS:

- A. Function
- B. Specification
- C. Installation
- D. Maintenance
- E. Troubleshooting

Relax and rejuvenate with this Ultrasonic Aroma Diffuser. Creates instant relaxing aromatherapy by adding your favorite essential oil.

By breaking up the mixture of water and essential oil into million of micro-particles, the stream of air is entirely diffused of activated ingredients of blended essential oil.

Under this richly enhanced effect of aromatherapy, your nerves would be eased and your skin would be moisturized.

FUNCTION

Product Name: Personal Aroma Diffuser
 Product Size: Ø 4.33in x H 4in.
 Input Voltage: DC 5V/600mA
 Power: 3W
 Water Tank Capacity: 50ml (1.69 oz.)

- A. Dome (cover)
- B. USB Cable and Power Adapter
- C. Base/Water Tank

- 1. Ceramic Disc
- 2. Water Level Line
- 3. Air Vent
- 4. Control Button
- 5. Safety Button

Control Button - press:	Mist	Light
Once	ON	ON
Twice	ON	OFF
Three times	OFF	OFF

Mood light flashes = water tank is empty, please add water.

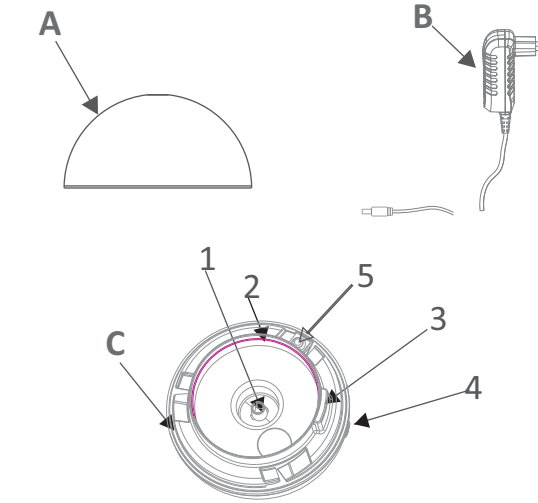

B

SPECIFICATION

Important Notes Before Use:

- A. Place the unit on an even surface. We recommend using distilled water to prolong the unit's life span. Corrosive liquid is not suitable for this unit.
- B. Add water (15-50ml) into the water tank.
- C. Use of water-soluble essential oil is recommended.
- D. If product is tripped during operation, water may enter the internal space. If this occurs, unplug the power and empty all water. Keep the unit upright in a ventilated place for 3 days. If unit does not function properly, please contact Sunpentown.

1.1-1.2 Connect Power or USB source

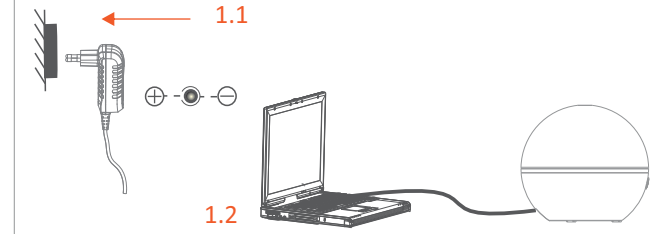

1.3 Connect to unit

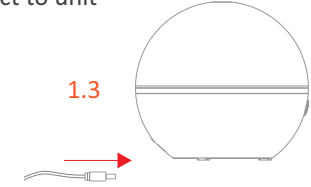

C

INSTALLATION

WARNING:

- 1. Unit must be on leveled surface with no tilt.
- 2. This appliance is not intended for use by persons (including children) with reduced physical, sensory or mental capabilities, or lack of experience and knowledge, unless they have been given supervision or instruction concerning use of the appliance by a person responsible for their safety.
- 3. Children should be supervised to ensure that they do not play with the appliance.
- 4. Unplug the appliance during filling and cleaning.
- 5. Do not empty water from the side which air vent is located.
- 6. Due to the rapid vibrating frequency of ultrasound, the water will become warm (up to 130°F) after some time.

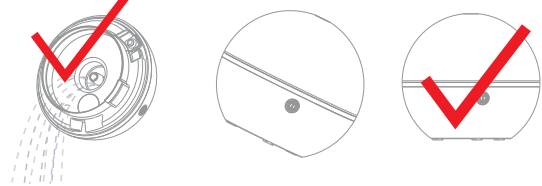

2.1-2.2 Remove cover by turning counter-clockwise and lift.

Note: when power is connected and cover removed, the light will illuminate.

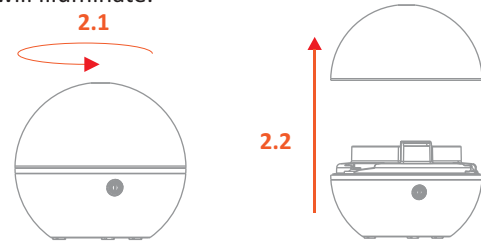

3.1 Fill water (max 50ml).

Do not exceed the max water level line

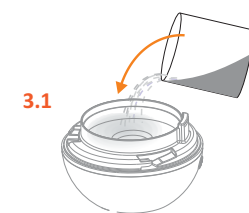

3.2 Add 2 to 3 drops of essential oil into the water.

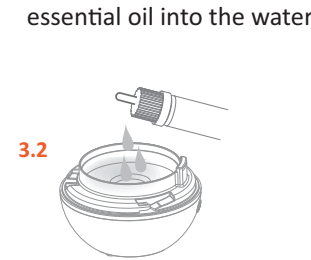

4.1-4.2 Replace cover by turning clockwise.

Note: once cover is replaced, light will go off.

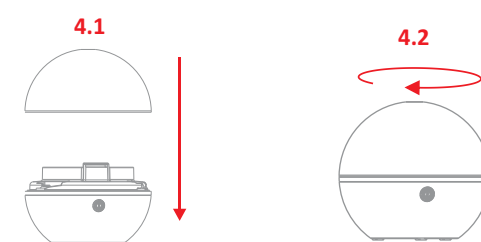

5. Press the power button

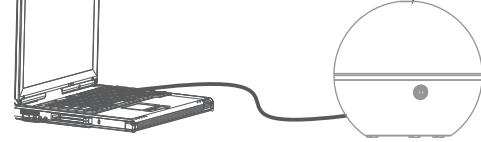

Note: Add water when light flashes.

C.2

INSTALLATION

1.1-1.2 Press the power button to turn off the unit. Disconnect power source.

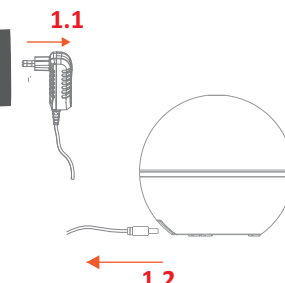

2. Remove cover.

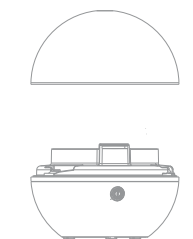

3. Empty water from the back side.

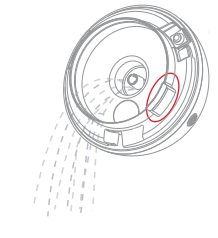

Note: avoid pouring from the side where air-vent is located.

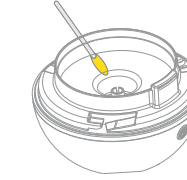

4. Use a clean swab or cloth to clean the unit (At least once per 3 days is suggested).

The ceramic disc has a life span of approx. 3,000 hrs. For replacement ceramic discs, please contact Sunpentown at 1-800-330-0388 or visit www.spt-usa.com.

D

MAINTENANCE

Sympton	Possible Cause	Solution
No Mist	Power supply is not connected	Check power connection. Press the button
	Insufficient water	Add water
	Water overflow (exceed 50ml)	Pour away excess water
	The cover is blocked by water drops or mineral buildup	Clean with a swab and keep the misting vent clean
	The ceramic disc has reached its life span (approx 3,000 hours)	Please contact Sunpentown for replacement
Water gets warm	Water bubbles in the misting vent	Clean the bubbles with cloth
	This is normal. Due to rapid vibrating frequency of ultrasound, water can get heated up to 130°F.	

Notice:

- 1. Light flashing denotes water level is close to empty.
- 2. When cover is removed, one of the LED illuminate.
- 3. Unit will only operate when there is enough water and cover is properly placed.
- 4. If cover is removed while unit is operating, the diffuser will stop working. When cover is replaced, press the power button to resume operation.

E

TROUBLESHOOTING

Your Guarantee

If this product is found to be faulty as a result of faulty materials or workmanship within one year from date of purchase, it will be repaired free of charge.

This guarantee is subject to the following terms:

- Sunpentown must be notified of the fault.
- Proof of purchase must be presented to Sunpentown's nominated representative.
- The warranty will be void if the product is modified, misused or repaired by an unauthorized person.
- The warranty after repair will not be extended beyond the original one-year period.
- All replacement parts will be new or reconditioned.
- Parts, which are replaced, become the property of Sunpentown.
- The warranty applies for the use of the product in the USA only.

What is NOT COVERED:

- Warranty does not include freight charges.
- Damage due to installation error, product abuse and/or misuse.
- Incidental or consequential damage caused by possible defects with this product.
- Labor cost incurred for the installation and/or removal of a possible defective unit.
- Damage to product caused by improper power supply voltage, accident, fire, floods or acts of nature.
- Failure of product resulting from unauthorized modifications to the product.
- Improper installation or failure to perform the necessary maintenance.
- Normal wear and tear on parts or replacement of parts designed to be replaced.
- Damage to personal property from use of product.
- Replacement or repair of household fuses, circuit breakers, wiring or plumbing.

This GUARANTEE is in addition to your Statutory Rights

SUNPENTOWN INTERNATIONAL INC.
 14625 Clark Ave. City of Industry, CA 91745
 Tel: 800-330-0388
 service@sunpentown.com
 www.sunpentown.com