

The PTX500E-DC-3U Transmitter is a component in a Digital Electricity™ line powering system. When paired with a VoltServer receiver unit, a Digital Electricity™ (DE) system is formed (see diagram). If a person or foreign conductor comes in contact with the DE wiring, power is disconnected; preventing fire, equipment damage and personal injury. The PTX500E-DC-3U is certified to safety and EMC standards by a **Nationally Recognized Test Laboratory**.



PTX500E-DC-3U Front View



PTX500E-DC-3U Rear View

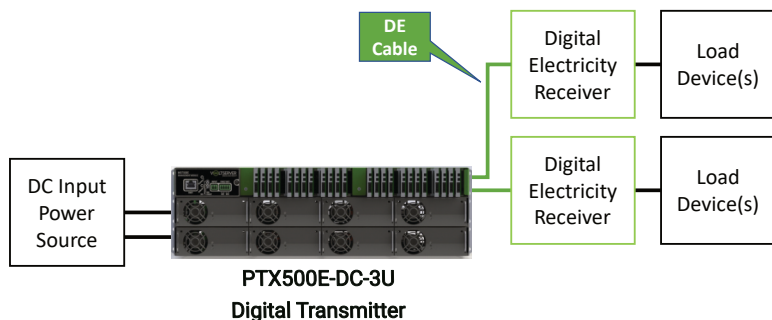

Digital Electricity™ is a **Limited Power Source** per IEC/UL/CAN 62368-1 suitable for supplying a **Class 2 circuit** under **NEC Art. 725** and **CEC Rule 16-200**. (Note: Always follow local codes).

Specifications

TYPE	PARAMETER	SPECIFICATION	NOTES
Input	Voltage	42-75 VDC	
	Max Current per Shelf	400 A	Maximum circuit breaker size is 200A per input connection. PTX500E-DC-3U has two shelves, rated up to 152A each
Output	Voltage	315-350 VDC (336 VDC Nominal)	Digital Electricity output
	Total Power	Up to 10.8kW	
	Number of Output Channels	Up to 24 Transmitter Cards	
	Max Current per Channel	Up to 3.0A	Use design rules for calculating actual output
	Max Distance	Contact VoltServer	
	Cable Capacitance	20-40 pF/ft	
	Environment	Access Location	Restricted Access Location Only
Operating Temperature		-20°C (-4°F) to 50°C (122°F)	Requires operation in a conditioned environment to ensure reliable operation
Altitude		Up to 2000m	
Humidity		5 to 95% Non-condensing	
Mechanical	Dimensions	17.7" W x 15.9" L x 5.25" H (449mm x 402 mm x 133.2mm)	Fits 19" (48mm) racks 3RU tall (5.25 inches, 133.4mm)
	Weight	Fully populated 60 lbs (27.22kg)	
Approvals	Safety	IEC/UL/CAN 62368-1 EN 55032 (CISPR 32) - Class A, FCC Part 15B - Class A,	
	EMC	EN 300 386 v2.1.1, EN 50121-4	
	Others	CE, RoHS	
Communication/ Signals	Ethernet	RJ45, 10/100Mbps	Remote monitoring and control via web GUI, SNMP v2c
	Dry Contact Alarm Output	1x Normally Open (NO) 1x Normally Closed (NC)	Two relay outputs, NO and NC. Can support alarm circuitry with maximum steady state current of 500mA at 25C.
	Dry Contact Alarm Input	1x NO or NC	Software selectable
Box Contents	Hardware Kit	[See page 3]	

Detailed Dimensions

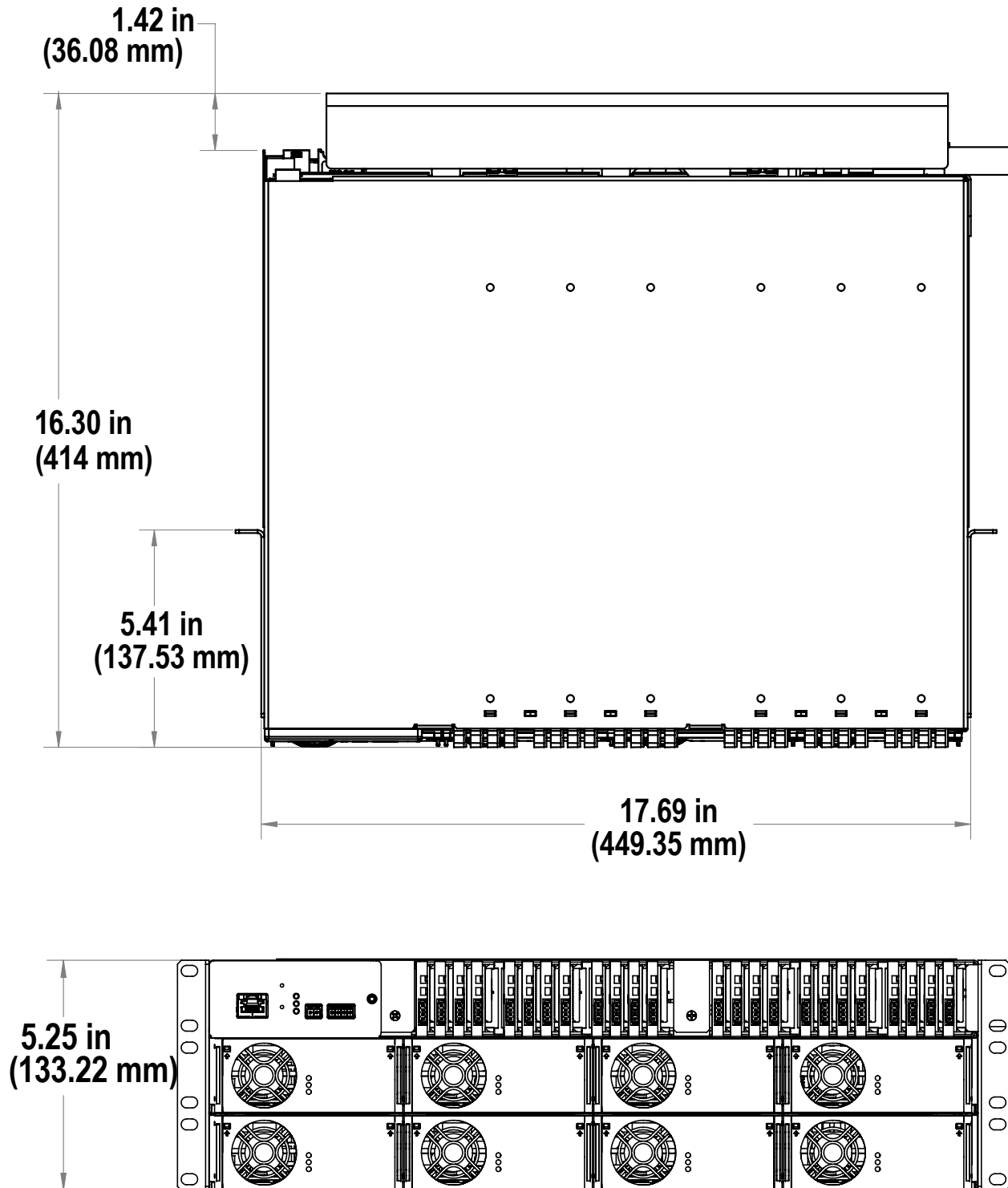

WARNING!

Ensure that the unit is de-energized before contacting any exposed conductors.

WARNING!

The voltage rating of the transmission wiring between VoltServer Transmitter and Receiver(s) must be a minimum of 300Vrms.

WARNING!

The minimum wire gauge for use with VoltServer Transmitters is 20AWG copper conductors. Mutual conductor capacitance shall be no more than 40pf per foot or 164 pF per meter.

WARNING!

VoltServer Transmitter outputs are intended to be used with VoltServer Receiver products only.

WARNING!

This equipment is not suitable for use in locations where children are likely to be present.

Warranty Statement

There are no serviceable parts within the PTX500E-DC-3U, MGT500E, or PM500-DC. Opening or modifying these modules will void the warranty.

Included Parts List

- 1x PTX500E-DC-3U transmitter chassis
- 1x MGT500E management card
- 1x PM500-DC power module
- 1x Rear cover
- 1x 0.5ft RJ45 CAT5E cable for CAN bus connection
- 1x 1ft RJ45 CAT5E cable for second CAN bus connection
- 1x Dry Contact Input Connector (MFN: 1745894)
- 1x Alarm Relay Output Connector (MFN: 1952283)
- 8x 18-8 lock-nuts, 3/8"-16 thread size for 48V input connections (MFN: 96278A527)
- 1x 18-8 Stainless Steel Locknut with External-Tooth Lock Washer 10-32 Thread Size for supplementary ground connection (MFN: 96278A411)
- 2x 1/4-20 x 1/2" Phillips 18-8 stainless machine screw for rear cover (MFN 96278A511)
- 1x Ground Lug, 2 Hole with Inspection Window, 4/0 Flex, 1/4" Stud, 5/8" Stud Spacing, 45 degree (MFN: YAZV282TC14FX45)
- 4x 48V input Lug, 2 Hole with Inspection Window, 4/0 Flex, 3/8" Stud, 1" Stud Spacing, 45 degree (MFN: YAZV282TC38FX45)
- 1x 10-12AWG #10 connector ring terminal for supplementary ground connection (MFN: 0190700123)
- 2x 1/4"-20, 18-8 Stainless Steel Locknut with External-Tooth Lock Washer for supplementary ground connection (MFN: 1952283)

Symbols



Hazardous Voltages present when energized. Do not open the unit while it is energized.



This symbol indicates the protective earth terminal for the device. See "Grounding Requirements" section.



This symbol indicates the supplementary ground terminal for the device. See "Grounding Requirements" section.

Components and Accessories (Sold Separately)

- **TX550-01:** Transmitter Cards (Required)
- **PM500-48DC:** Additional Power Modules
- **CBL-TX-001:** pre-terminated cable, TX550-01 to Phoenix Connector, 10ft, 20AWG
- **TRMBLK-01-19-8:** Transmitter Terminal Blocks & DIN Rail Populated with 8 x 4 Pair Positions per 19" DIN Rail
- Receiver Modules such as RX548, RX554, etc.

Installation Instructions

NOTE

Input and Output wiring and over current protection must be installed in accordance with all local and national electric codes and requirements.

NOTE

After making/terminating input and output connections, ensure that there are no bare contacts or conductors. Conductors must be properly insulated from contact.

NOTE

Readily accessible disconnect devices, such as a breaker, must be incorporated external to the PTX500E-DC-3U for each source.

NOTE

It is a common practice in highly resilient systems to design for N+1 redundancy. When applied to the PTX500E-DC-3U transmitter chassis, this typically means that one additional PM500-DC module is added to the system in addition to the number of modules required to power the load.

THE CIRCUIT BREAKER SIZE MUST BE 200A ON EACH OF THE TWO (2) INPUT CIRCUITS, and the INPUT WIRING GAUGE MUST ALWAYS BE 4/0.

Physical Installation

The PTX500E-DC-3U transmitter is designed to be rack-mounted in a 19" rack using provided rack-mount brackets. Use 19" to 23" rack mounting adapters, as required.

If installing multiple transmitters, space them a minimum of ½ RU apart, with preferred spacing of 1 RU. Rack-mount hardware (rack screws, rack nuts, clips, etc.) is not included.

CAN-bus cable

Ensure that the small Ethernet style CAN-bus jumper cables are installed between the top and bottom portions on the rear of the chassis. There are 2 CAN-bus jumper cables. This allows communication between the MGT500E Module and PM500-DC48 Modules.



Input Power Source

The PTX500E-DC-3U accepts 42-75VDC. Prior to making input power connections, review the polarity markings on the rear of the PTX500E-DC-3U unit.

Proper polarity must be maintained to avoid damage.

The circuit breaker size must be 200A on each of the two (2) input circuits and the input wiring gauge must always be 4/0.

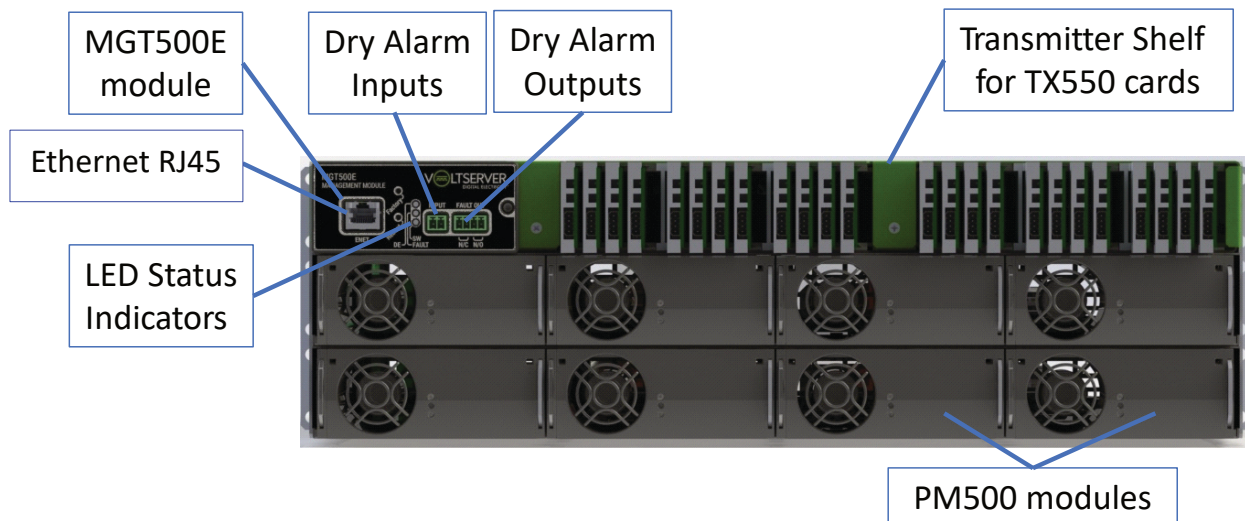

Installation Instructions (cont.)

Input Power Connections and Wiring

Caution: Ensure source power is disconnected/de-energized prior to making connections.

Caution: Always confirm polarity of the power cables from the power plant before making connections. Reversed polarity can cause permanent damage to the PTX500E-DC-3U unit.

1. Crimp Input Lugs Onto Wire - Once power polarity has been successfully verified, make the connections to the PTX500E-DC-3U. The double lugs sized for 4/0 AWG TelcoFlex cable are provided in the hardware kit for this purpose.
2. Secure Input Lugs - Use the provided 3/8"-16 lock-nuts to secure the lugs to the PTX500E-DC-3U input terminals. Torque the nuts to 120in.lbs.
3. Install Back Cover - Attach the clear back cover to the PTX500E-DC-3U using the supplied 1/4"-20 screws and mounting stand-offs. Torque the nut to 10in.lbs
4. Input power to the PTX500-DC-3U can be verified with a multi-meter with no PM500DC power modules installed. This will prevent the PM500DC power modules from being damaged by reverse connection.

Min. Input Power Conductor Size	Power Lugs (2 hole, 3/8" studs, 1" spacing)
4/0 (0000) AWG	YAZV282TC38FX (straight)
	*YAZV282TC38FX45 (45°)
	YAZV282TC38FX90 (90°)

*Provided with the unit

Input Power Locations (4 total)

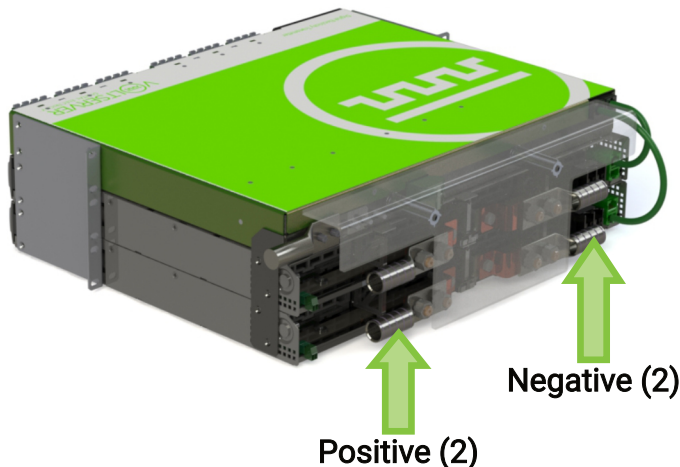

Protective Earth Requirements

The PTX500E-DC-3U feature a double lug connection with 1/4" studs and a 5/8" spacing on the rear of the chassis for protective earth grounding. A 4/0 (0000) AWG double lug is provided in the accessory pack for this purpose. The minimum diameter of the protective earthing conductor must be 4/0. Use the provided 1/4"-20 lock-nuts to secure the lug to the PTX500E-DC-3U grounding bracket. Torque the nuts to 77in.lbs

Min. Protective Earth Conductor Size	Grounding Lugs (2 hole, 1/4" studs, 5/8" spacing)
4/0 (0000) AWG	YAZV282TC14FX (straight)
	*YAZV282TC14FX45 (45°)
	YAZV282TC14FX90 (90°)

*Provided with the unit

Supplementary Earth

In addition to the required protective earth ground connection, a supplementary earth ground location is provided on the PTX500E-DC-3U. The intended use of the supplementary ground connection is to provide a means to connect a local ground for improved EMC performance. Use the provided lock-nut and ring terminal to secure the terminal to the supplementary grounding stud. Torque the nut to 32in.lbs

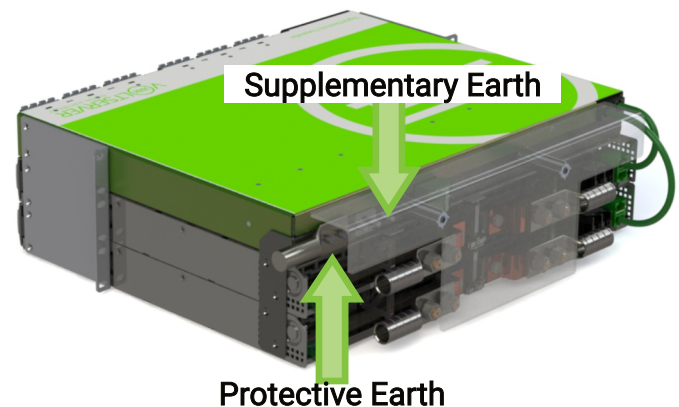

Output Power Connections and Wiring

Each Digital Electricity™ TX550 card has a four pin output connector (Phoenix Contact p/n:1778858). 20AWG output connectors are recommended for output connections to terminal blocks. Larger conductors are recommended for long cable runs. Contact VoltServer for more information.

Installation Instructions (cont.)

PM500-DC Power Module Installation

Up to eight (8) PM500-DC modules may be installed in the PTX500E-DC-3U Transmitter shelf in the lower power bay openings. PM500-DC modules may be inserted in any bay of the shelf. All PM500-DC Power Modules may be “hot swapped” for in-service maintenance purposes.

- Place a small screwdriver under the release button in the windows located in the upper corners of the PM500-DC module

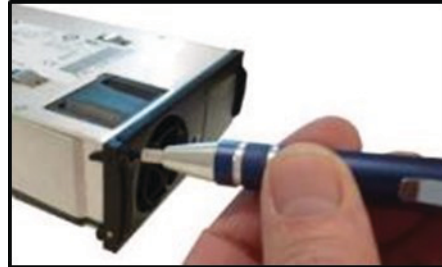

- Pull the screwdriver downwards to release the PM500 extraction handle, repeat on opposite side



- Push PM500-DC module into a bay of the transmitter shelf until it firmly seats in the connector



- Press extraction levers upward until they fully seat and lock into place. The PM500-DC module is now locked into place. Repeat the above steps for each PM500-DC module, perform the above steps to release the extraction handles, and pull the PM500-DC from the transmitter using the handles



Installation Instructions (cont.)

TX550 Transmitter Card Installation

The transmitter shelf can accommodate up to 24 TX550 transmitter cards which drive a single pair (two conductors) to a receiver. VoltServer recommends the practice of using multiple pairs to drive a receiver for redundancy purposes. When driving multiple pairs to a VoltServer receiver, all TX550 transmitters driving those pairs **MUST** be from the same PTX500E-DC-3U shelf.

TX550 Card Insertion

- Select the proper slot and slide TX550 card into the transmitter shelf
- Seat the card by pressing on the plastic faceplate until the card edge fingers seat into the backplane connector
- To remove the TX550 card, pull the card using the indentation on the top of the plastic faceplate
- TX550 cards may be hot-swapped as required

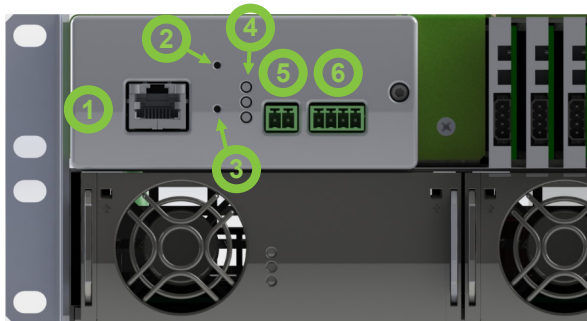
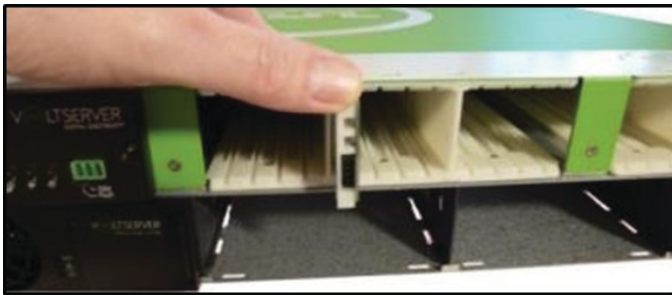

The MGT500E management module provides software control and fault alerting capability for the PTX500E product. The features present on the front panel of the MGT500E are described here:

① Ethernet Port

The management module provides the system with an Ethernet (IPv4/ IPv6) network interface. This allows the system to be connected to a local network for remote monitoring and management.

② Factory Reset Button

Hold for 5 seconds to reset the software settings to factory defaults. The “SW” LED will blink blue while reset is in progress. Transmitter card status will not be affected during the reset process.

③ Software Reboot Button

Push momentarily for SW reboot. The software LED will turn off for about 30 seconds. Once LED has turned back on, software is accessible.

④ LED Indicators

LED information is provided on the last page of this quick start guide.

⑤ Dry Contact Input

The PTX500E-DC-3U features a dry contact input enables the user’s system to trigger the software policy to enable features such as load shedding for battery back-up. **The dry contact input should be connected to either an open circuit or closed circuit. Do not apply voltage to the dry contact.** For details on this functionality, contact VoltServer support.

Maximum Cable Length	3 m
Accepted Wire Gauge	14-22 AWG
Default Operating Mode	Open Circuit

⑥ Alarm Relay Output

The alarm relay output port can be used to notify external devices of fault conditions on the PTX500E-DC-3U.

Maximum Cable Length	3 m
Accepted Wire Gauge	14-22 AWG

Pin	Connection	Description
1	NO	Normally open
2	GND1	Common for NO connection
3	GND2	Common for NC connection
4	NC	Normally closed

Software Instructions

IP Discovery via Zeroconf

The IP address of a device on a local network may be determined using the device's hostname plus .local as the domain. The default hostname is printed on the unit label on the rear of the device.

Absent any ethernet switch the device can be connected directly to a laptop/PC using an Ethernet patch cable, i.e. "crossover connection."

By default, the device hostname is "volserv-XXXX" where XXXX is the last 4 characters of the device's MAC address. For example, if the device's MAC ends with :42:09, the default hostname will volserv-4209.

Test network connectivity to the device by opening a command prompt and running **ping [hostname].local**

```

Command Prompt
Microsoft Windows [Version 10.0.17134.590]
(c) 2018 Microsoft Corporation. All rights reserved.

C:\Users\IEUser>ping volserv-4209.local

Pinging volserv-4209 [192.168.8.184] with 32 bytes of data:
Reply from 192.168.8.184: bytes=32 time=2ms TTL=64
Reply from 192.168.8.184: bytes=32 time=5ms TTL=64
Reply from 192.168.8.184: bytes=32 time=4ms TTL=64
Reply from 192.168.8.184: bytes=32 time=12ms TTL=64

Ping statistics for 192.168.8.184:
    Packets: Sent = 4, Received = 4, Lost = 0 (0% loss),
    Approximate round trip times in milli-seconds:
        Minimum = 2ms, Maximum = 12ms, Average = 5ms

C:\Users\IEUser>
    
```

Software Web UI Login

Software configuration is performed via a web browser interface. Access the web interface by opening

**http://[hostname].local or
http://[IP address]**

in a supported browser. The factory-programmed password can be found on the unit label on the rear or side of the device.



The default username is admin.

IP Configuration & Hostname

Hostname and static IPv4 address may be configured from the Network Settings page. Click "Apply Changes" to save new settings.

After network settings are saved, the browser will redirect to the new IP address or hostname after settings are applied. In most cases it will be necessary to login to the web UI again after the redirect.

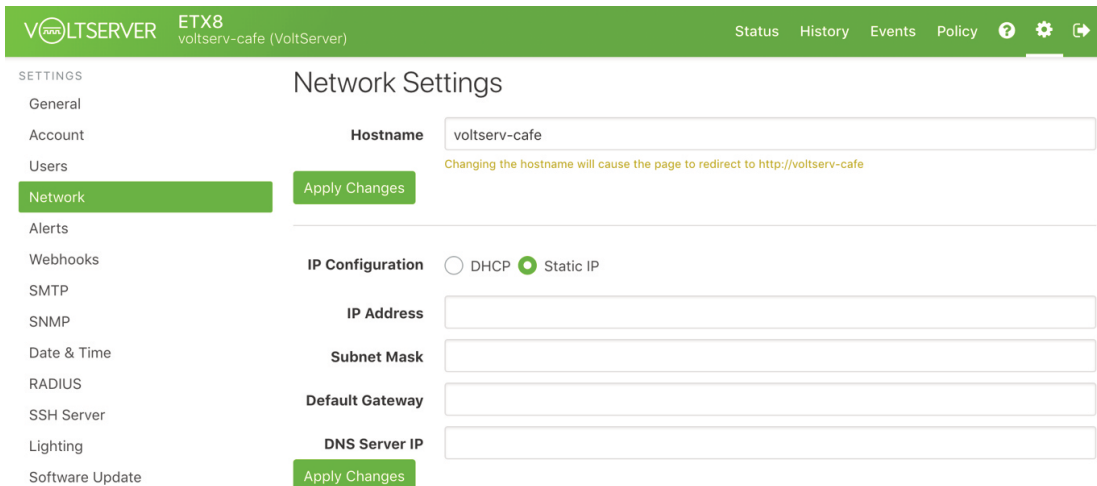

Output Channel (TX550) LED Codes

NORMAL STATES	LED PATTERN	NOTE
Normal Operation	GRN ● OUTPUT ON RED ○ FAULT OFF BLU ○ SYSTEM BRIEF BLINK (heartbeat)	
Boot-up	GRN ○ OUTPUT OFF RED ○ FAULT OFF BLU ● SYSTEM BLINK (booting up)	Start-up sequence occurs when power is first applied to the receiver.
Pre-charge DE	GRN ● OUTPUT BLINK (slow) RED ○ FAULT OFF BLU ○ SYSTEM OFF	Part of normal start-up sequence
Pre-charge Load	GRN ● OUTPUT BLINK RED ○ FAULT OFF BLU ○ SYSTEM OFF	Part of normal start-up sequence

FAULTS	LED PATTERN	FAULT CODE	TROUBLESHOOTING
Disconnected	GRN ○ OFF RED ● BLINKS=FAULT CODE BLU ○ OFF	1 Blink	Check DE wiring and connections
Startup		2 Blinks	Check wiring Check receiver Check cable length & gauge
Transmission		3 Blinks	Check wiring Check receiver Check cable length & gauge Reduce load on the receiver output
Overload		4 Blinks	Reduce load on the receiver output Check receiver Check wiring
Temperature		5 Blinks	Reduce ambient temperature Reduce load
Short Circuit		6 Blinks	Check for damaged wiring Check for short in termination/ connectors Reduce load
Ground		7 Blinks	Check wiring Check earth ground on receiver Check earth ground connection on the transmitter
Input Power		8 Blinks	Ensure transmitter card is properly inserted Check power module, MGT, main power
Internal		9 Blinks	Internal hardware failure Contact VoltServer support

Management Unit (MGT500E) "SW" LED Codes

LED PATTERN	DURATION	MEANING
BLU ●	5s after power on/ reboot	Software module power-on and pre-boot. Pushing the "Factory" button during this time will cause the device to boot into Recovery Mode
GRN ●	30s (approx.)	Software is booting (green "heartbeat" blink pattern)
GRN ●	Until reboot	Software is running
BLU ●	20s (approx.)	Factory reset is in progress
BLU ●	Until reboot	Software is in Recovery Mode (blue "heartbeat" blink pattern)

Document Revision History

Revision	Date	Description
A	1/13/2020	Initial release (split from Rev C of PTX500E)