

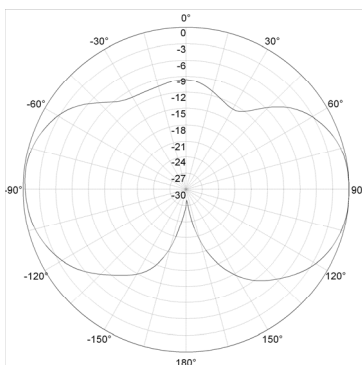

**TerraWave Solutions® 802.11n 2.4/5 GHz 6 dBi Outdoor
MIMO Omnidirectional Antenna with RPTNC Plug Connectors, 6-Pack Dual Band Leads**

TerraWave’s 6 dBi outdoor multiple-input and multiple-output (MIMO) omnidirectional antenna is designed to operate enterprise class 802.11n MIMO access points. With dual-band leads, each cable supports both 2.4 and 5 GHz, making it an ideal and aesthetically pleasing antenna to support demanding outdoor applications in next generation IEEE 802.11n wireless communication systems. The rugged enclosure makes this antenna perfectly suited for use in a warehouse or manufacturing environment where it must withstand exposure to moisture and dust. Includes an L-Bracket for mast and or wall mounting. Industrial beam clamps could be purchased as an additional option but are not included, sold separately. This antenna is also RoHS compliant. Every TerraWave antenna is covered by the Company’s two-year TerraNet warranty program. For questions and to purchase product, contact a regional sales executive at 210-375-8482, 800-851-4965 or sales@terrawave.com. Visit www.terrawave.com for additional information.

Specifications	
Model	M6060060MO1D3602O
Frequency Range	2400~2500 / 5150~5850 MHz
Bandwidth	100 / 700 MHz
Gain	6 dBi
Vertical Beamwidth	35°/25°
Horizontal Beamwidth	360°
VSWR	Typical $\leq 1.5 - 2.0$
Nominal Impedance	50 Ohms
Polarization	Vertical
Isolation	≤ -15 dB
Max Power	10W
Lightning Protection	Not DC Grounded
Connector	RPTNC Plug with 36" Pigtail
Dimensions	5.9" x 7"
Weight	3.15 lbs
Mast Mount Diameter	1.37"-1.97"
Operating Temperature Range	-40°F to +158°F
Wind Load	134 mph

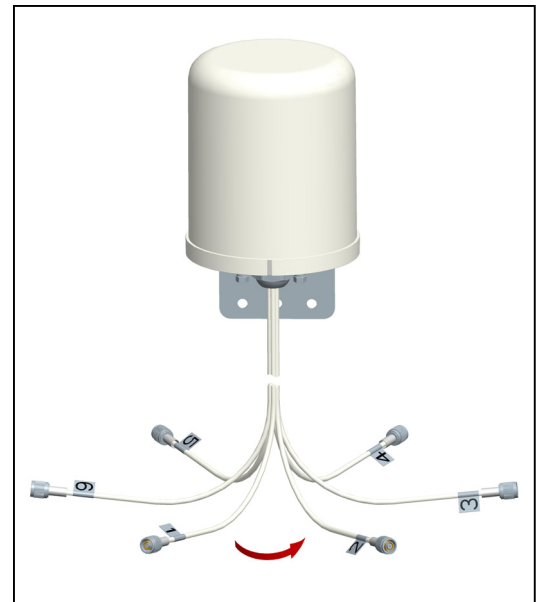

E-Plane Pattern

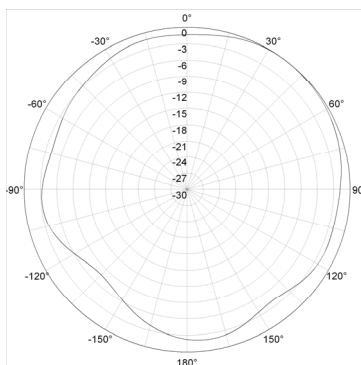

H-Plane Pattern

2.4 GHz

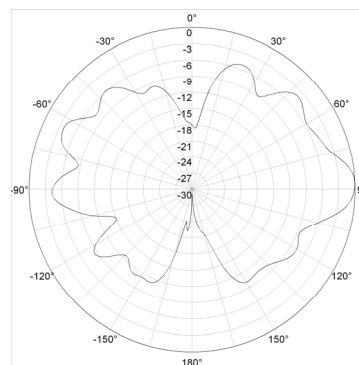

E-Plane Pattern

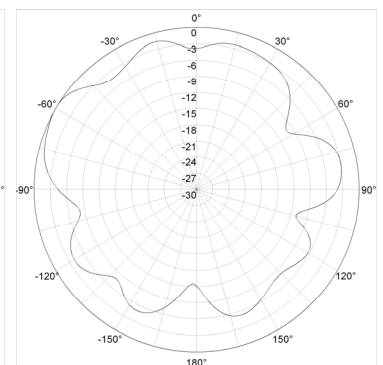

H-Plane Pattern

5 GHz



**TerraWave Solutions® 802.11n 2.4/5 GHz 6 dBi Outdoor
MIMO Omnidirectional Antenna with RPTNC Plug Connectors, 6-Pack Dual Band Leads**

Mounting Information for M6060060MO1D36020

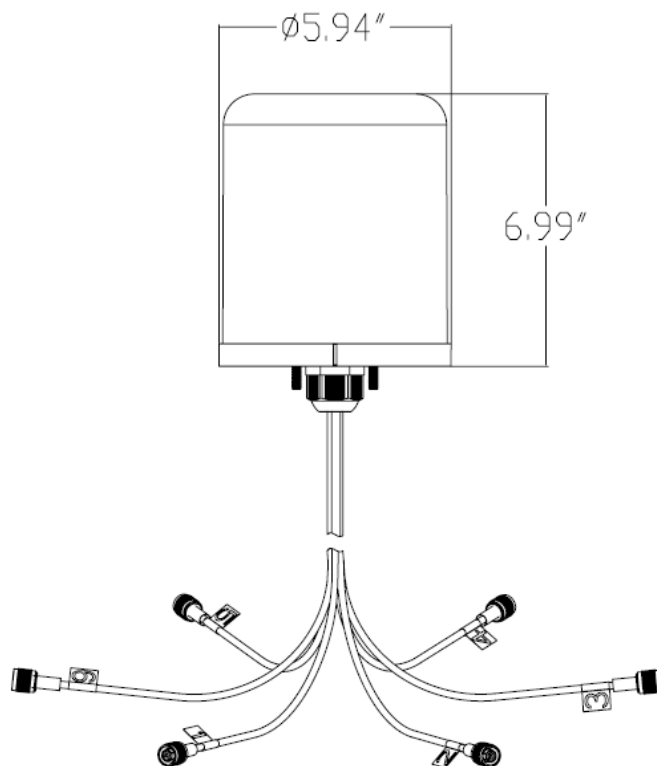
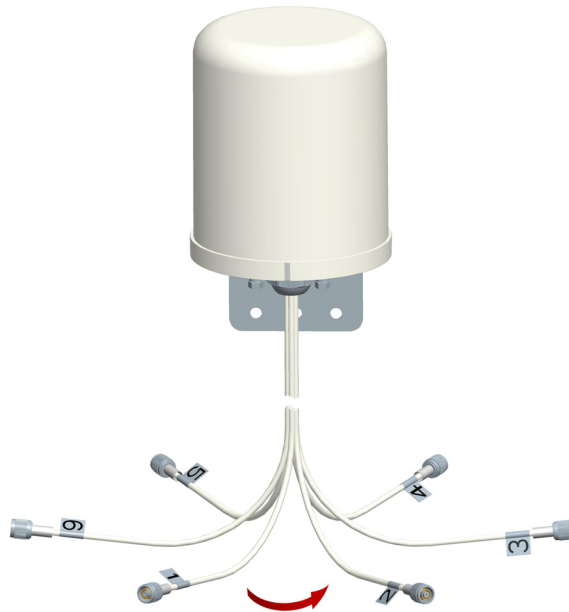



**TerraWave Solutions® 802.11n 2.4/5 GHz 6 dBi Outdoor
MIMO Omnidirectional Antenna with RPTNC Plug Connectors, 6-Pack Dual Band Leads**

Mounting Bracket Information for M6060060MO1D36020

