

WB-K210-S

Safety Grated Waveguide Bridge Kit, 24 in x 10 ft, with two 10 ft 6 in base shoe posts

Product Classification

Product Type Waveguide bridge kit

General Specifications

Application Base shoe

Cable Runs, quantity 24

Pipe, quantity 2

Dimensions

Height 3,200.4 mm | 126 in

Width 609.6 mm | 24 in

Length 3048 mm | 120 in

Pipe Length 3,200.4 mm | 126 in

WB-K210-S

Outline Drawing

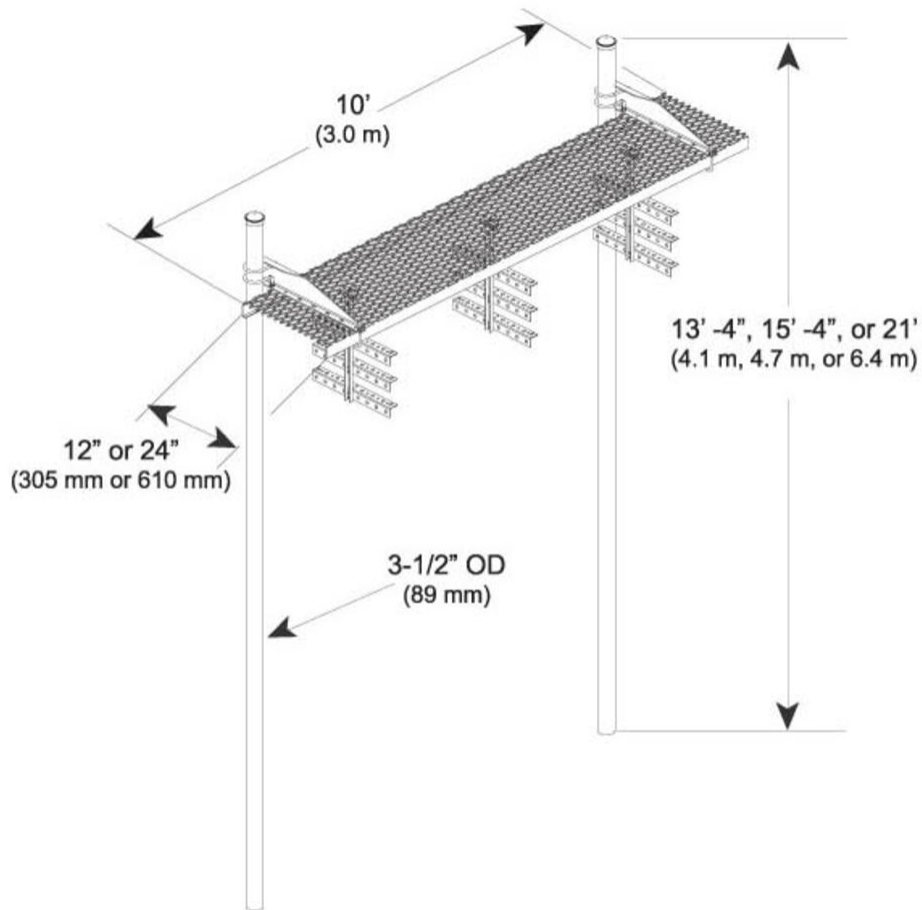

Material Specifications

Material Type Hot dip galvanized steel

Packaging and Weights

Included Caps | Channel | Hardware | Posts | Support brackets | Trapeze

Packaging quantity 1

Weight, net 166.5 kg | 367.069 lb

Regulatory Compliance/Certifications

Agency **Classification**

WB-K210-S

CHINA-ROHS	Below maximum concentration value
ISO 9001:2015	Designed, manufactured and/or distributed under this quality management system
REACH-SVHC	Compliant as per SVHC revision on www.commscope.com/ProductCompliance
ROHS	Compliant



Included Products

- MF-126 — Base Shoe Pipe Column, 10 ft 6 in
- WB-CY210 — Safety Grated Waveguide Bridge Channel, 24 in x 10 ft
- WB-LB24-3 — Waveguide Bridge Support Bracket, 24 in wide for 3-1/2 in OD legs
- WB-T24-3 — Trapeze Kit, triple tee, 24 in wide, three rungs