



UP134 IN-GROUND PACKAGE FOR CRAWL & TODDLE (USED ON MODEL #UP130, UP131, UP132, & UP133)

Parts List		
DESCRIPTION	QTY	PART NUMBER
SUPPORT PIPE	6	403202

*Unless Otherwise Specified, All Units of Measure are Each
Items listed below Hardware Complete line are included with Hardware Complete Number*

Warning: During Installation, Hardware And Small Parts Are Choking Hazards For Young Children. Store Unused Parts Appropriately Until Assembly Is Completed. Once Assembly Is Completed, Remove Any Unused Parts From The Play Environment And Dispose/Save Them In A Secure Location. Any bolt end protruding more than two full threads beyond the face of the nut causes risk of clothing entanglement. Promptly cut-off flush, file smooth, and treat to prevent corrosion.

INSTALLATION INSTRUCTIONS:

UP130 & UP131

1. Dig footing holes as shown in Bottom & Elevation Views. **Note:** Site must be level and clean of debris.
2. Attach Front Wall, Back Wall, and Support Pipe to Soft Ramp and Soft Deck using 3/8" x 1 3/4" P.B.H.C.S. w/Patch and 3/8" Flat Washer. See Detail 047.
3. Attach Right Wall, Left Wall, and Support Pipe to Soft Deck using 3/8" x 1 3/4" P.B.H.C.S. w/Patch and 3/8" Flat Washer. See Detail 047.
4. Plumb & level the entire assembly and tighten all fasteners.
5. Pour concrete footing with 4" to the top and taper away from posts for water drainage. Allow to cure at least 48 hours before use. **Note:** Temporary bracing may be required until concrete cures.

UP132 & UP 133

1. Dig footing holes as shown in Bottom & Elevation Views. **Note:** Site must be level and clean of debris.
2. Attach Coated Deck, Coated Ramp, and Support Pipe to Front Wall and Back Wall using 3/8" x 1 3/4" P.B.H.C.S. w/Patch, 3/8" Flat Washer, 3/8" Flat Washer (1 1/4" O.D.), and 3/8" Hex Nut. See Detail 048.
3. Attach Left and Right Wall to Support Pipe and Coated Steps using 3/8" x 1 3/4" P.B.H.C.S. w/Patch, 3/8" Flat Washer, 3/8" Flat Washer (1 1/4" O.D.), and 3/8" Hex Nut. See Detail 048.
4. Plumb & level the entire assembly and tighten all fasteners.
5. Pour concrete footing with 4" to the top and taper away from posts for water drainage. Allow to cure at least 48 hours before use. **Note:** Temporary bracing may be required until concrete cures.

MAINTENANCE PROCEDURE:

Periodically check hardware for tightness, and tighten as necessary. Always check all parts for breakage or wear, and immediately put equipment out of service until any faulty parts found are repaired or replaced. Also Check all metal parts for rust, paint loss and touch-up if necessary with paint. Check for welded areas and verify integrity. Check periodically resilient surfacing for appropriate depth and remove extraneous materials that could cause injury, infection, or disease. Maintain detailed installation, inspection, maintenance, and repair records for each public-use playground equipment.

UP134 IN-GROUND PACKAGE FOR CRAWL & TODDLE (USED ON MODEL #UP130, UP131, UP132, & UP133)

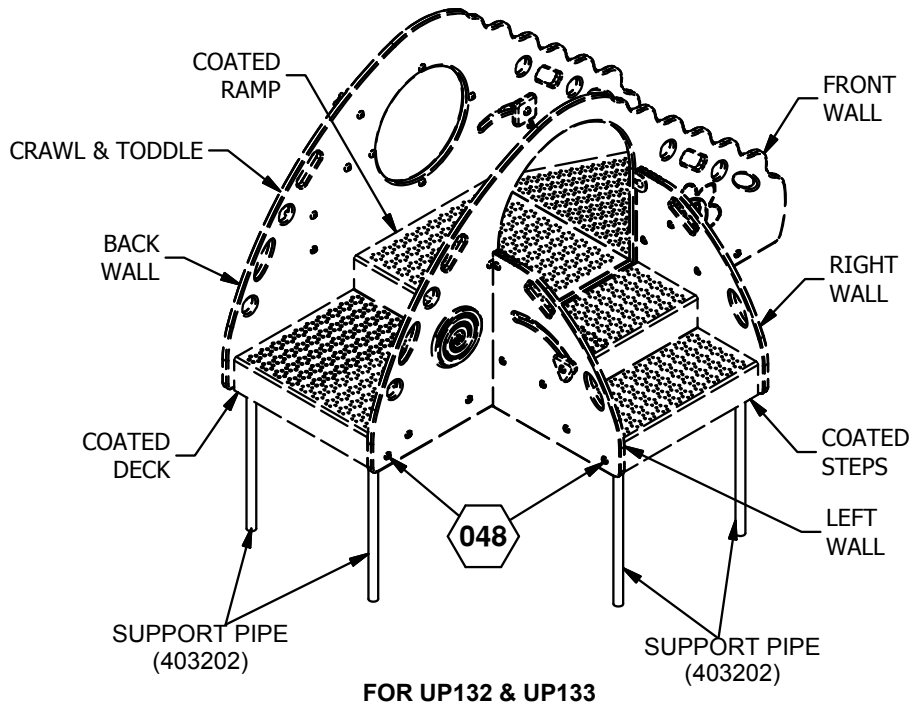
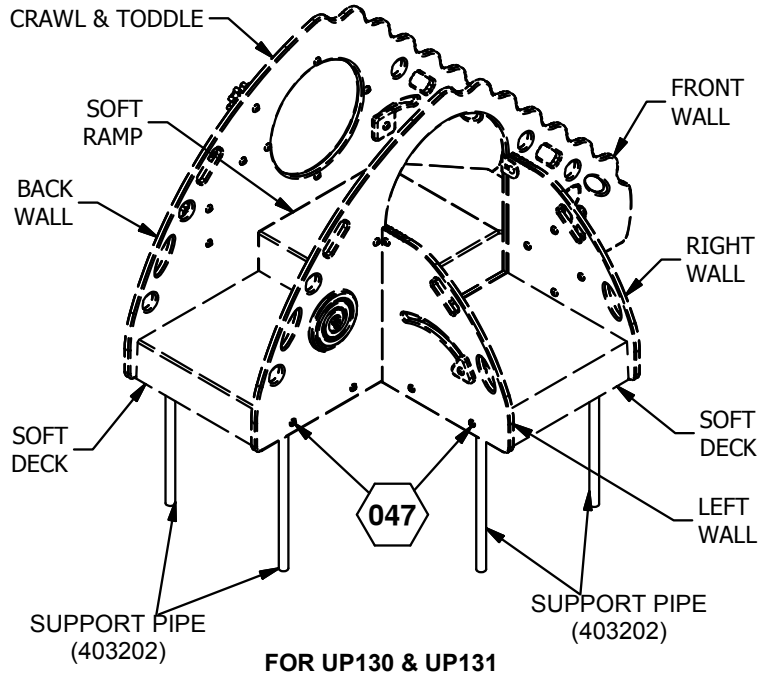

= INSTALLATION DETAIL

FINISHED ASSEMBLY

Issued/Revised: 01/20/12

UP134 IN-GROUND PACKAGE FOR CRAWL & TODDLE USED ON MODEL #UP130 & UP131

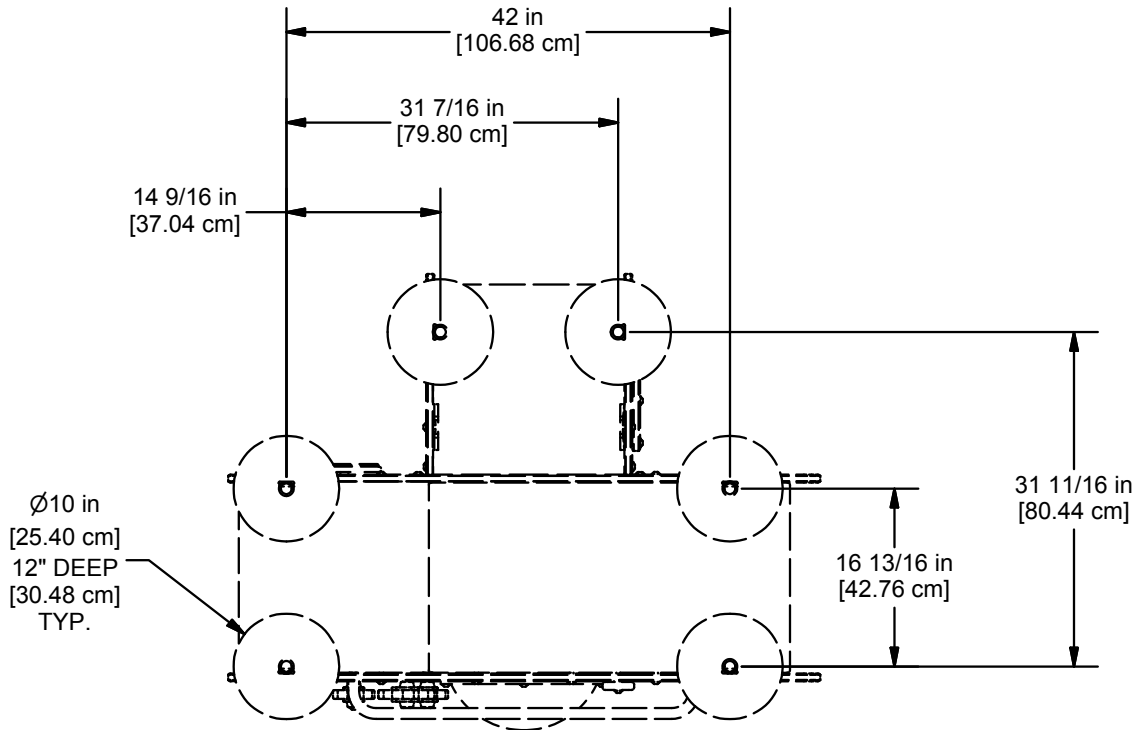

BOTTOM VIEW

CONCRETE REQ'D:
0.12 CUBIC YARDS
[0.90 CUBIC METERS]

SHOCK ABSORBING PROPERTIES OF SURFACING MATERIALS VARY. IF YOU DETERMINE THAT LESS THAN 10" OF SURFACING IS REQUIRED, MAKE-UP THE DIFFERENCE IN ELEVATION WITH EARTH BEFORE APPLYING SURFACING. IF MORE THAN 10" IS REQUIRED, MAKE UP THE DIFFERENCE BY REDUCING THE DEPTH OF THE GROUNDHOLE BY NO MORE THAN 2".

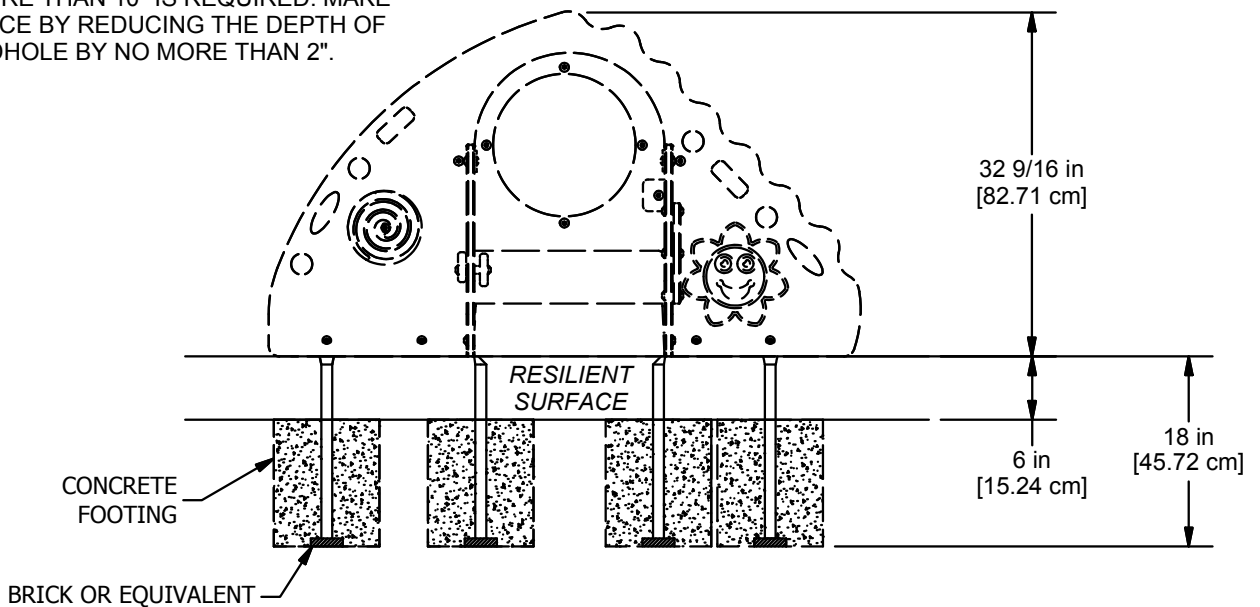

ELEVATION VIEW

Issued/Revised: 01/20/12

UP134 IN-GROUND PACKAGE FOR CRAWL & TODDLE USED ON MODEL #UP132 & UP133

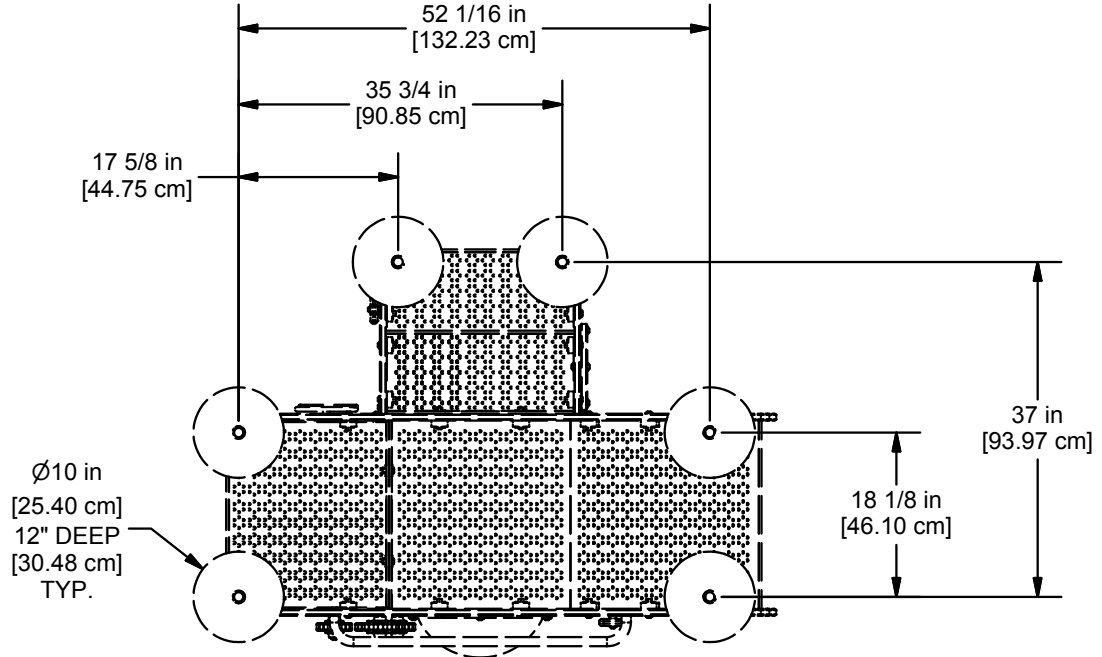

BOTTOM VIEW

SHOCK ABSORBING PROPERTIES OF SURFACING MATERIALS VARY. IF YOU DETERMINE THAT LESS THAN 10" OF SURFACING IS REQUIRED, MAKE-UP THE DIFFERENCE IN ELEVATION WITH EARTH BEFORE APPLYING SURFACING. IF MORE THAN 10" IS REQUIRED, MAKE UP THE DIFFERENCE BY REDUCING THE DEPTH OF THE GROUNDHOLE BY NO MORE THAN 2".

CONCRETE REQ'D:
0.12 CUBIC YARDS
[0.90 CUBIC METERS]

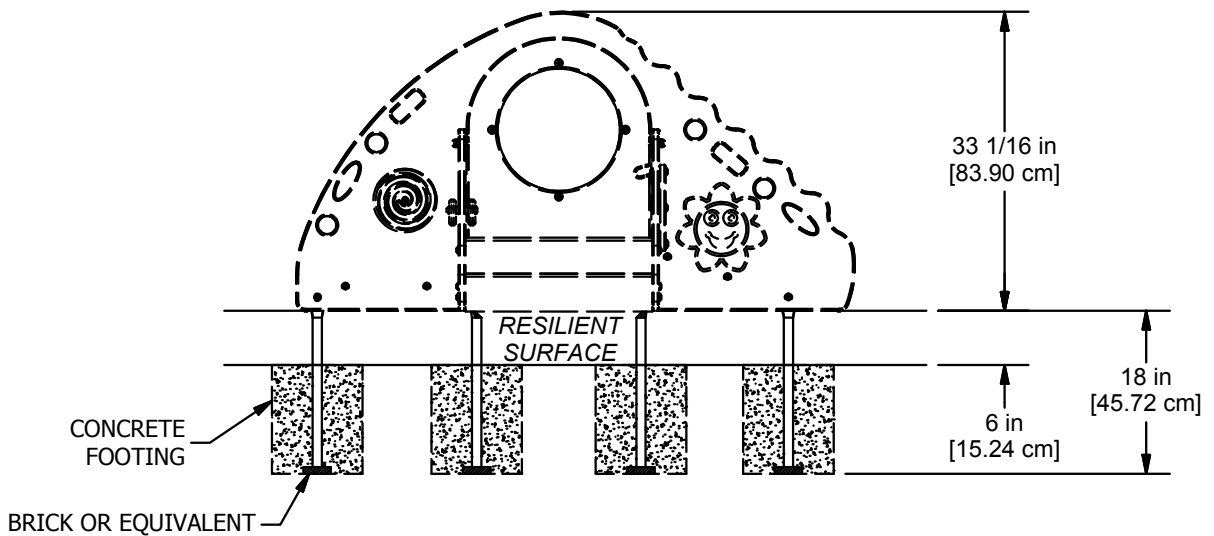

ELEVATION VIEW

Issued/Revised: 01/20/12

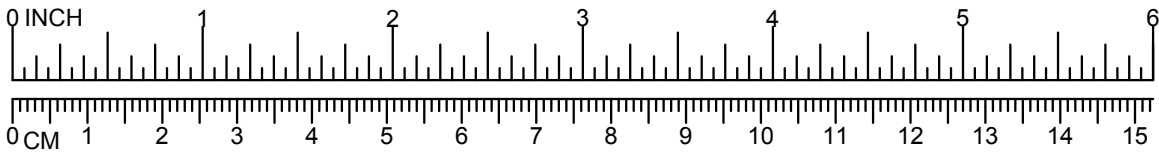

UP134 IN-GROUND PACKAGE FOR CRAWL & TODDLER (USED ON MODEL #UP130, UP131, UP132, AND UP133)

