

LIVINGPONDS™

Design & Construction Guide



EASY STEPS

To Create a Superior Easy to Maintain Water Garden.

S A V I O
EXCELLENCE

Compact Pond
Package 550 gal

10'



6'

SAVIO LIVINGPONDS™

Savio Livingpond™ designs and equipment work in harmony to create low-maintenance, living water gardens that stay healthy with minimal effort. The equipment and the pond are designed with a philosophy that emphasizes low-maintenance combined with natural beauty. In no time you will have a backyard oasis to enjoy for many years to come.

TABLE OF CONTENTS

Welcome	3	Install Skimmerfilter™	16-18
Choose a Location	4	Attach Pump	19
Level the Site	5	Finishing Up	20-22
Measurements	6	Maintain	23-25
Mark Outlines	7	Options	26-27
Place Equipment	8	Repair	28
Dig Levels	9	Accessories	29
Add Underlayment & Liner	10	Notes	30
Planting Bog Shelves	11	Troubleshooting	31
Waterfall Installation	12-14		
Finish Coping	15		

SAVIO
ENGINEERING

WELCOME

Dear Pond Builder,

If you are new to water gardening you are about to embark on a voyage of discovery. Owning a pond is a rich and rewarding experience and SAVIO makes it easy.

If you are an experienced pond builder you may find we do things a bit differently, so we suggest that you take the time to review this guide in its entirety before starting.

Our goal is to help you to create ponds that look great and require minimal effort to maintain. The SAVIO equipment, the construction, even the design of the pond is formulated to give you the maximum amount of satisfaction with the least amount of work.

The best pond designs mimic nature. By encouraging a naturally balanced living system your pond will provide you with years of enjoyment. A SAVIO Livingponds™ does not require aggressive cleaning, annual draining, or excessive chemical treatments. This means less work and more enjoyment for you and your family.

Your friends at SAVIO wish you the best.

REMINDER: Read through the entire design and construction guide before starting.

SAVIO
ENGINEERING

TOOLS

Gather necessary equipment prior to installation.

- shovel
- 4' hand level
- utility knife
- scissors
- 12' length 2 x 4/large straightedge
- wheelbarrow
- #3 phillips screwdriver
- flat bladed screwdriver

STEP 1 – CHOOSE A LOCATION



Pick a Location

Choosing a location is the first step toward building your pond. Locate the pond for easy access and viewing from your home. The ideal placement allows the pond to be a part of everyday living. Make it the focal point so that it dominates the viewing area. Enjoy your pond from the kitchen, your living room or upstairs deck. Place it to receive ample summer and winter sun and avoid putting it under pine or fruit bearing trees.



Assemble Components

The Savio Compact Pond Package has everything you need. Unpack the Compact Skimmerfilter,™ Waterfall Weir,™ liner and underlay at this time.



Outline Pond Shape

Use a garden hose to outline the pond shape. An open, gradually curving design such as a bean or kidney shape encourages better circulation and pond health.

TIP:

Avoid eccentric shapes, sharp curves and niches. They trap debris, cause excessive liner folds and create stagnant water.

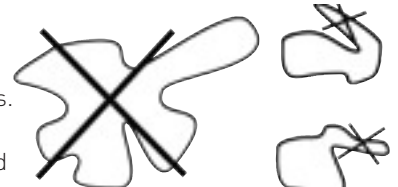

STEP 2 - LEVEL THE SITE



Level the Site

Careful attention to site levelling will create a more professional finished pond and make the installation process easier. Prior to excavation, the pond site must be leveled on all sides. A 2 x 4 or long straightedge may be used.



Setting the Level

Place 2 x 4 across the pond. Set builder's level on top of the board. Add or remove dirt to the area until the bubble is centered.



Add / Remove Soil

Repeat the leveling procedure on all sides using this technique until the pond is level all the way around.

STEP 3 - MEASUREMENTS

6' x 10' pond

550 gallons

Outside dimensions: 6' x 10'

Coping Shelf: 6" deep
 Shallow area: 10" deep
 Mid Level : 15" deep
 Deep area: 24" deep

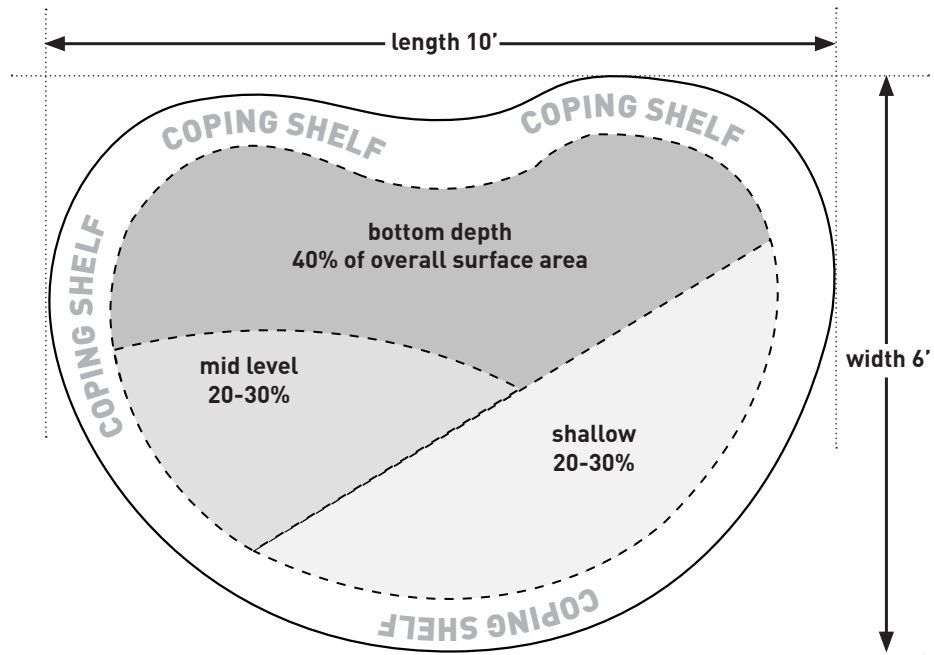

Can I build it smaller?

If you are limited by space considerations you can build a smaller pond with this kit. You'll have some extra liner left over. You can use this liner to make your pond deeper than 24".

- deepest level** - 40% of the overall surface area of the pond. Provides a basin of cooler water for fish in summer and serves as a collection area for landscape debris & waste. Slope this level to a point so that debris will collect in one specific area. (Depth 24")
- mid level** - 20-30% of the pond surface area. Slope downward slightly (~5°) toward the bottom of the pond. (Depth 15")
- shallow level** - 20-30% of the pond surface area. Use for planting areas. Slope downward slightly (~5°) toward the bottom of the pond. (Depth 10")
- coping shelf** - 6" to 8" wide margin reserved for rockwork that holds the edges of the pond in place. (Depth 6")

STEP 4 - MARK OUTLINES



Mark Pond Outline

Once the site has been leveled re-draw the outline of the pond. Marking the overall pond shape and shelf locations with spray paint prior to excavation will help guide the digging process and ensure that the pond stays within the limits of the Savio Pond Package.



Mark Coping Shelf

Once the outline has been marked, create another outline 6" into the pond for the coping shelf - a transitional area where pond and landscaping meet.



Mark Depth Shelves

Using the diagram on page 6 mark the locations of each of the remaining levels of the pond: shallow, mid-level and deep area.

STEP 5 – PLACE EQUIPMENT



Locate Equipment

Position the major components prior to excavation. The waterfall should face the viewing area. Place the Skimmerfilter™ on the opposite side of the pond.

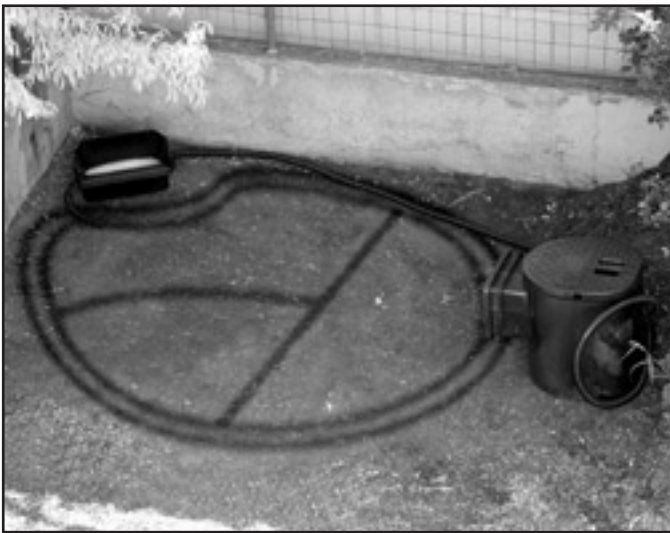

Locate Equipment

Lay kink free hose along ground so that it connects both areas. This provides the best view, encourages good circulation, simplifies maintenance and hides the face of the Skimmerfilter.™

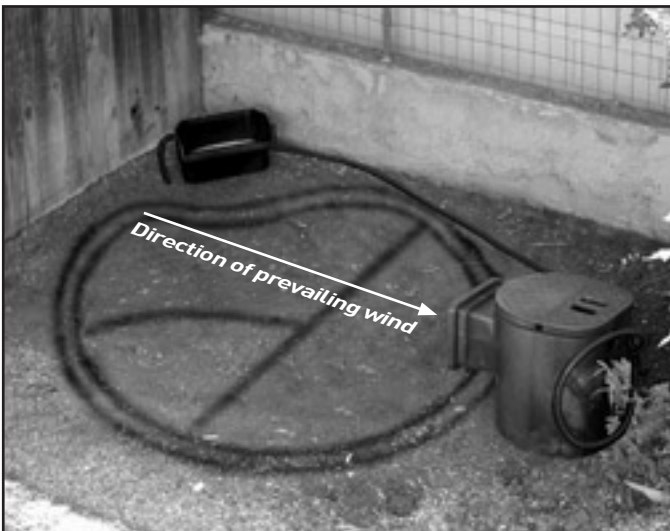

TIP:

Positioning the Skimmerfilter™ on the downwind side of the pond will aid in the effective collection of floating debris. This is less important than placing the Skimmerfilter™ opposite the waterfall but it is a significant design consideration.

STEP 6 – DIG LEVELS

**Dig First Level**

Mark the position of the equipment and then remove. Next, dig the pond to a depth of 6" to create the coping shelf level.



Warning! Before undertaking any excavation project, always check first with your local utility company for the presence of underground wires, water and gas lines.

**Dig Shallow and Mid Levels**

Excavate the shallow areas of the pond to a depth of 10" and the mid-level of the pond to a depth of 15". **Gently slope shelves (~5°)** toward the lowest point of the pond easiest cleaning. Set aside excavated soil to build the waterfall runway, place the rest 2' away from the outer edge of the pond to use as backfill for the coping shelf.

**Dig Deepest Level**

Excavate the deepest level of the pond to a depth of 24". **Make the pond sides nearly vertical.** A 60°-75° drop encourages debris to settle to the pond bottom, discourages predators and makes access for maintenance easy. Slope the deepest level to one point to make it easy to collect debris later on. Double check measurements for all levels. When the excavation is complete check for sharp rocks or roots that may damage the pond liner and remove if necessary

STEP 7 – ADD UNDERLAYMENT AND LINER



Place Underlayment

Once excavation is complete it is time to create the containment that will hold the water and act as the foundation for your Livingpond™. Use underlayment to protect and extend the life of the liner. If necessary, cut protective felt underlayment into overlapping pieces to cover the entire pond site.



Smooth Underlayment

Smooth wrinkles and folds in underlayment against the contours of the pond. The easiest method is to start from the bottom of the pond and work outward toward the edges.



Place Liner

Cover the underlayment with one piece of liner. Center the liner so an roughly equal amount remains on all sides of the excavation. Work from the bottom and sides outward, smoothing out wrinkles and folds as in the previous step.

[BE CAREFUL: Rocks wedged in shoe treads can damage liner]. **DO NOT TRIM LINER AT THIS TIME.**

TIP:

In case you puncture the EPDM liner, we've included a self-adhesive patch with your kit. For instructions, see **How to patch liner** on page 28.

STEP 8 – PLANTING BOG SHELVES (optional)

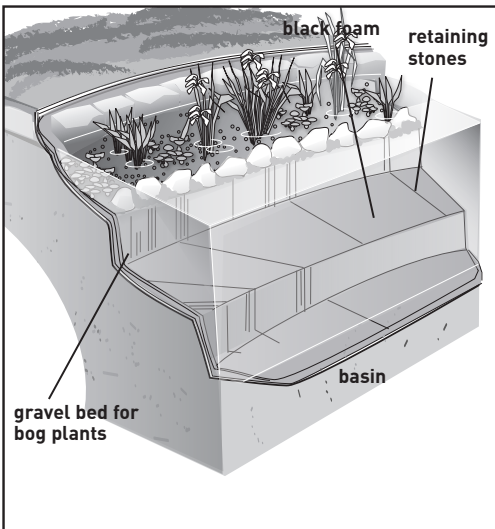

Planting Bog Option

Bog plants grow on the outer edges of ponds and thrive in moist soil or shallow water. A contained area for bog plants provides stable areas for healthy growth while preventing them from overtaking the entire pond.

It's Easy to Build

Use retaining stones to border your shallow shelf. Use black foam to fill between the stone. Add 4" to 6" of $\frac{3}{4}$ " - 1 $\frac{1}{2}$ " rounded gravel in the bed. Place the plants directly into the gravel bed.

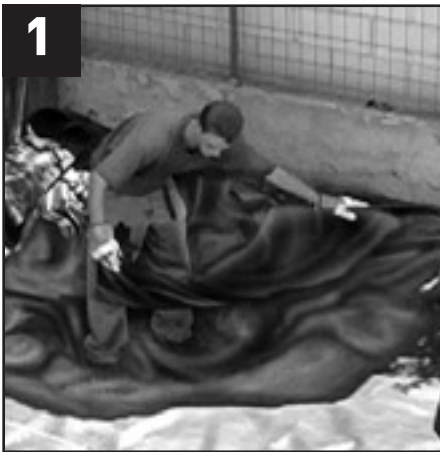

1 Place scrap underlay to protect the liner from abrasion and sharp edges.



2 Place rockwork to form a border along the edge of the bog shelf.



3 Use a bead of black foam to secure and seal the base of the rockwork.



4 Fill behind rockwork with $\frac{3}{4}$ " - 1 $\frac{1}{2}$ " stones.



5 Bogs can be multi level too. Start another course of rockwork to build a planting bog for the next level.



6 Add foam and more stones **Note: The bottom of the pond should be kept smooth for easy waste removal.**

STEP 9 – WATERFALL INSTALLATION



WATERFALL WEIR™



1 Level the soil in the area where the assembly is to be placed. Use blocks to add height to the waterfall.



2 Connect kink free hose to back of Waterfall Weir.™



3 Place the Waterfall Weir™ and level the unit front to back and side to side.



4 Place liner over the face of the waterfall. Leave a moderate amount of slack in the material.



5 Mark position of the weir opening by rubbing the liner with a hard object such as a screwdriver or a blunt scissor edge.

BUILD A STREAM

You can enhance your water feature by purchasing some additional underlayment and EPDM liner. Use this extra material to create a dramatic waterfall or stream. A stream adds interest but also some complexity to the project. Here are some helpful hints based on the experience of a professional installer.

Make it at least 6" deep

When a streambed becomes clogged with debris or ice, water may overflow from the liner and drain the entire pond. To prevent overflow, provide enough depth to the waterfall and stream so water level is at least 6" below the top edge of the liner (the deeper the better). When the bed becomes clogged with debris and water backs up, it will remain contained in the lined runway.

WATERFALL INSTALLATION



6 Cut away the liner to the shape of the opening.



7 Attach liner bracket and liner to waterfall weir by installing 4 tack screws **halfway** into each corner. (Front of seal has recessed screw holes.)



8 Next, install the remaining screws halfway. Tighten all screws evenly **by hand**, until flush with the faceplate.



9 Use rockwork to create interesting drops and cascades. A few buckets of water may be useful for discovering the best layout.



10 The final result with rockwork in place. Note: the rock running up the sides of the waterfall will be backfilled to hide the liner later on.



11 Black foam fills voids in the rockwork and forces water to run over the rocks instead of beneath and between them.

Pond surface area = 2x Stream surface area

Shut off the pump in any aquatic system and where does the water go? To the lowest point, of course. The way to ensure you have enough containment to hold all the water in your system is to use this simple rule of thumb: *Make the pond surface area at least twice that of the streambed surface area.*

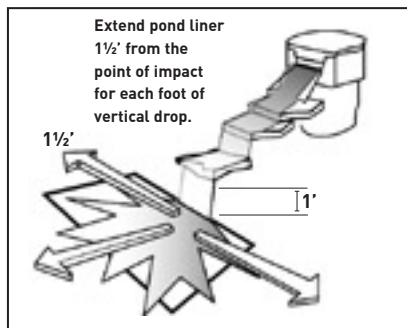

Contain Splashing

Leaks most often occur in the waterfall. To keep water from splashing out of the system, extend the liner 1½' out on both sides, from the point of water impact for each foot of vertical waterfall drop. (see diagram at left)

STEP 10 – INSTALL MEDIA



Media Pad

Place filter media pad into the waterfall weir.



Mesh Bag

Fill the mesh bag with rocks for ballast. Use large gravel, lava rock or stones.



Final Step

Place mesh bag on top of media.

STEP 11 – FINISH COPING



Coping Shelf

Secure edges of the pond and liner by adding rockwork to the coping shelves. Use flat bottom rocks, roughly 6" - 7" in height. **Leave the area in front of the Skimmerfilter™ free of rockwork for now.**



Backfill Liner

Pull liner up tightly against the back of the coping shelf. Backfill with soil to hold it in place. The reason for this coping shelf is twofold: it disguises and secures the liner while creating a slight elevation around the pond to prevent unwanted landscaping debris from washing into the system.

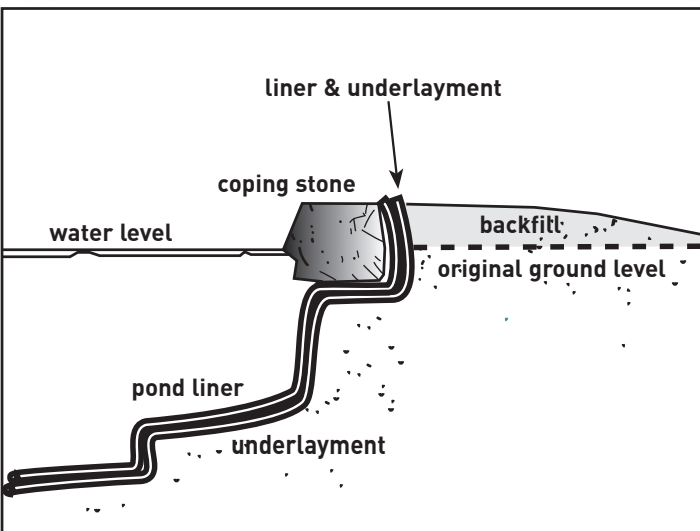

Cross Section

The diagram at left shows a cross-section of the finished coping shelf .

STEP 12 – INSTALL SKIMMERFILTER™

One of the most crucial steps is installing the Skimmerfilter.™ For best results carefully follow the steps below.



1 Fill the pond with water to accurately determine water level on all sides before installing the Skimmerfilter.™ Water level should hit partway up the coping stones. Verify that the water level is a few inches below the edge of the liner on all sides.



2 With pond full, mark position of water level on the liner at the Skimmerfilter.™ location with white chalk.



3 Dig a hole for the Skimmerfilter.™ in the previously determined spot. Place the hole 4" back from the coping shelf, measuring 24" across, with a depth of 14" below the marked water line.



4 Dig a channel 7" below the water line, measuring 15" wide, from the hole to the pond. The Skimmerfilter.™ neck rests on this channel. Compact and level the bottom of excavation. Do not dig too deeply or the soil may settle unevenly.



5 Place the Skimmerfilter.™ in the hole. Verify that the face of the Skimmerfilter.™ is flush with the back wall of the lined coping shelf.



6 Check to make sure the water level meets the skimmer 3/4" inches below the top of the neck. Adjust up or down by adding or removing soil.

INSTALL SKIMMERFILTER™



Trim underlayment in front of the Skimmerfilter™.



Level the unit front to back and side to side. Dig the front of the hole 1/4" deeper than the back to compensate for settling. **Check water level once again.**



Backfill around the Skimmerfilter™ with the lid in place. Use moist sand or pea gravel, if this is unavailable, use gravel and loose soil (free from clumps).



Hand pack every two or three inches. Do not over compact. Lightly moisten the backfill to aid in settling.



Dig a trench for the kink free hose to the back of the Skimmerfilter. Extend this trench so that it connects to the waterfall weir.

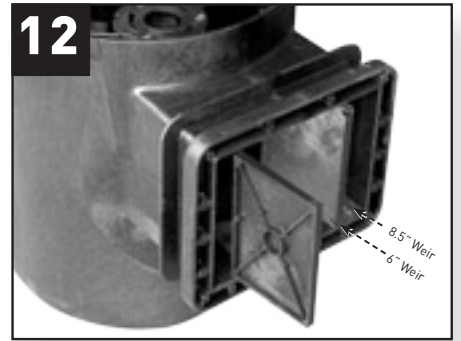

Insert weir dividers into Skimmerfilter™ neck. Use the tracks which correspond with the faceplate provided with your kit, as shown in the picture above. (6' x 10' pond uses innermost tracks)

INSTALL SKIMMERFILTER™ (continued)

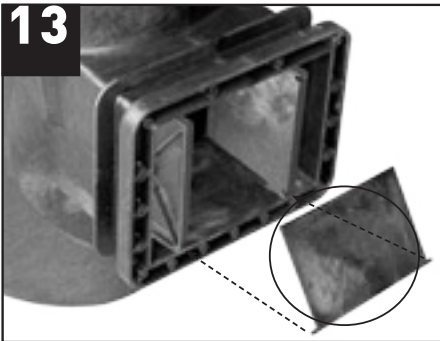

13 Push the weir door hinge tabs into notches on the weir dividers, using thumbs to hold tabs secure. Lay the door horizontal in the Skimmerfilter™ neck.



14 Position pond liner over the Skimmerfilter™ mouth and hold it in place. Smooth liner free of wrinkles and folds. Wipe clean.



15 Make a 3" wide incision through the centered liner 3/4" below the top of the Skimmerfilter™ opening.



16 Slide the faceplate in front to align the screw holes.



17 Use a #3 Phillips head screwdriver to install screws halfway into all four corners. Install the remaining screws halfway. Tighten top, bottom and sides alternately by hand until screw heads are flush to create a watertight seal.



18 After the faceplate is properly tightened use a knife to trim the liner inside the mouth of the Skimmerfilter™.



19 Hide the Skimmerfilter™ from view by extending the coping shelf rockwork to both sides of the Skimmerfilter™ opening. Place a flat rock across the Skimmerfilter™ neck.



20 Place a flat rock over the Skimmerfilter™ lid to camouflage. (optional)

TIP:

Leave Skimming Access

Do not to block the opening of the Skimmerfilter™ with rockwork or with plants. Leave it open to successfully pull debris from the pond surface. An easily removable faux rock or potted plant can be used to hide the Skimmerfilter's™ lid from view.

STEP 13 – ATTACH PUMP



**950 GPH
POND PUMP**



1
Cut a hole in the soft plastic grommet the same size as diameter of hose with a knife. Slide hose through grommet .



2
Cut to length leaving 12" of excess hose.

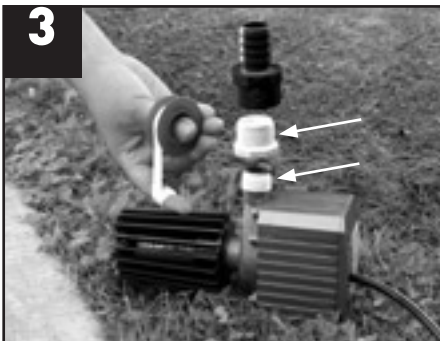

3
Put teflon tape onto pump connector threaded fitting and adapter. Assemble in the order shown.



4
Press hose onto pump adapter and secure with hose clamp provided.



5
Lower pump into skimmerfilter chamber

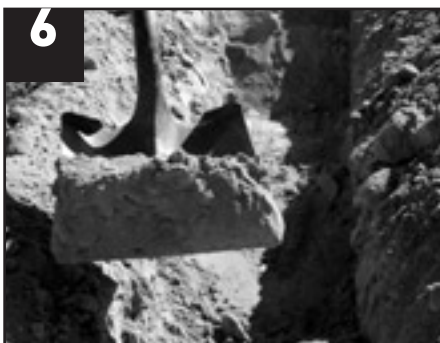

6
Use backfill dirt to hide the flexible hose.

FINISHING UP



Trim Liner

With the pond filled the weight of water will cause the liner to settle. Liner can be trimmed at this time though it is advisable to leave several inches extra of material.



Roll Liner

Roll the liner back down and hide the edge in backfill.



Blend

Use rockwork and backfill to hide the liner and to blend the new water feature into surrounding landscape.

FINISHING UP

**Start System**

To start the filtration system, simply plug in the pump. Initially the pond may be cloudy from the accumulated debris of rockwork and dust. Over the course of a few days this debris will settle and the pond will gradually clear.

**Add Bacteria**

Establish the ecosystem for plants and fish by adding *Savio Natural Beneficial Bacteria™*. The secret to good water quality is filtration and good filtration relies on beneficial bacteria. These naturally occurring microscopic organisms live on filter media and submerged pond surfaces. It takes four weeks after adding beneficial bacteria to a new pond for a filter to establish its ecosystem. Support the pond ecosystem and biomechanical filter with monthly treatments of **Savio Natural Beneficial Bacteria™** to keep water clear and balanced, increase oxygen levels and maintain the biological filter.

THE END RESULT



At last! All your hard work has finally paid off and you have a beautiful backyard paradise to enjoy for years to come. You'll enjoy the easy maintenance and superior water quality only a pond built with Savio products can provide.

Send Us Your Pictures



CARING FOR YOUR LIVINGPOND™

Keeping your pond looking beautiful is easy with Savio equipment. The next few pages offer helpful tips on how to keep your pond looking its best in all seasons.

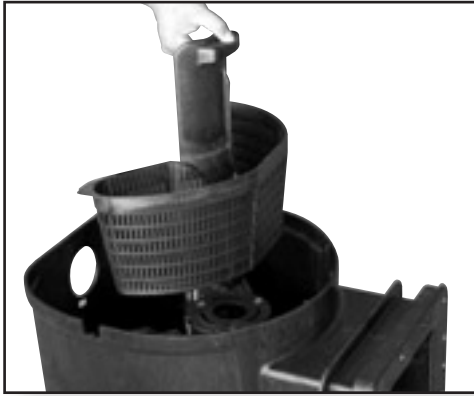

Remove Debris

Check and **remove debris captured in the Skimmerfilter™ leaf basket** every week or as needed. The frequency required will vary seasonally, with cleaning required more often in the Fall than at other times.



Clean Filter Media

Clean the filter media in the Waterfall Weir™ when the flow rate slows or becomes clogged with debris. Excessive cleaning kills the beneficial bacteria that reside on the filter media.

Do not use chlorinated water, hot water, soaps or chemicals on any filter media.

If you remove the media from the filter use clean water from the pond to rinse and do not allow the media to dry out during cleaning.

After cleaning the filter, add more **Savio Natural Beneficial Bacteria™** to the Skimmerfilter™ and Waterfall Weir.™



Clean Filter Mat

Inspect and **clean the filter mat** in the Waterfall Weir™ as needed. The filter mat can be cleaned when it appears dirty by dunking it in a bucket of clean pond water. Avoid using untreated tap water or harsh scrubbing as this can damage the colonies of beneficial bacteria growing on the filter mat.

CARING FOR YOUR LIVINGPOND™



Cleaning the Pond Bottom

A **long handled leaf rake net** belongs on the list of necessary equipment for every pond owner. Scoop settled debris out of the deepest point in the pond.



Add Bacteria

Add **SAVIO Natural Beneficial Bacteria™** to reduce maintenance and improve pond health. It breaks down organic sludge and debris and balances pond chemistry. Use it throughout the season and in particular when establishing a new pond, prior to adding fish, after pond cleaning and when feeding heavily during summer months.

Winter Equipment Care

Although outdoor ponds can run all winter, most do better when shut down or with the flow rate substantially reduced. Prepare ponds for winter in mid-to-late November, or when ice persistently develops on the surface of the pond.

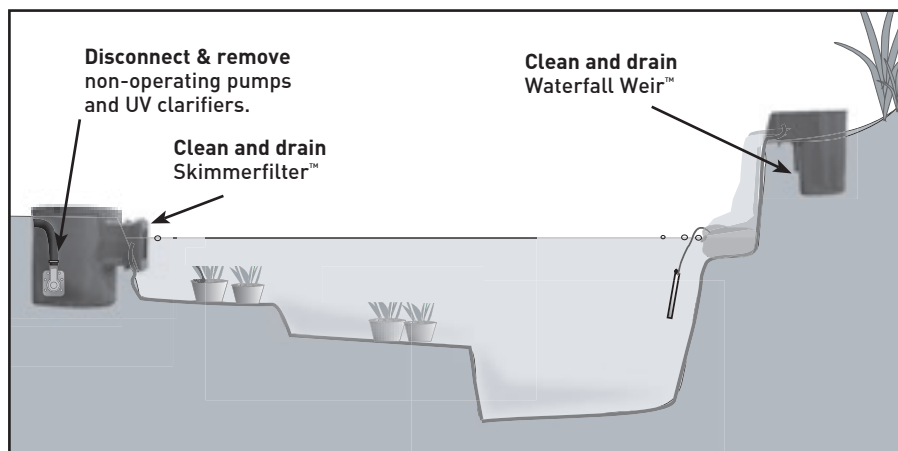

Remove, drain, clean and store the pump in an area that will not freeze. Drain the Skimmerfilter™ and Waterfall Weir™ at this time. To avoid freeze damage, disconnect the UV filter and store it indoors.

If fish are present, it is important in Fall to vacuum removing sludge and organic debris (dead leaves, grass, fish waste and algae).

Connect an aerator and de-icer to guarantee a healthy supply of oxygen and allow the exchange of other gases throughout the winter.

MAINTAIN WATER QUALITY

Below are some of the most common challenges for maintaining water clarity: **Hair and string algae**, stringy masses of green material that cling to rocks and liner. **Planktonic algae**, a single-cell organism that gives water a green, soupy cast. **Organic debris**, fish waste and the by products of a living pond that in high concentrations can pose health problems to fish. **Avoid using harmful chemicals that can harm the environment and the pond ecosystem.**



Hair & String Algae

Long, stringy or clumpy algae is often referred to as hair algae (aka blanket weed, string algae, beard algae). While a small amount of hair algae on underwater surfaces is beneficial to pond health. Add **Savio Natural Barley Extract™** or **Savio Greenex® Micro Granules™** to create a healthy pond balance, which, in turn, curtails the development of hair algae.



Planktonic Algae

Phytoplankton or planktonic algae are present in even the clearest water but can become a problem when their numbers increase to the point that water becomes green and soupy. This phenomenon when it develops suddenly is known as "algae bloom". Use **Savio Natural Beneficial Bacteria™** and a **UV Clarifier** to treat planktonic algae.

UV Clarifiers

Add a **Savio UV Clarifier™** to decrease the workload of the filtration system, reduce maintenance and give water a crystal clear appearance. If using an ultraviolet clarifier, turn it off for 24 hours when adding beneficial bacteria. This gives it the opportunity to settle and attach to filter media and pond surfaces. Replace UV bulbs annually for best performance.



Organic Debris

Heavy amounts of decomposing organic debris, fish waste and excessive fish food can pose health problems to fish. Evaporation leaves behind impurities, such as minerals and salts, which can become detrimental. Throughout the season perform **small, partial water changes**. Remove 15% - 20% of the water every 20 to 30 days. Never change more than 1/3 of the water at one time. Discharge the nutrient rich water onto surrounding landscape. Refill the pond and add water conditioner and **Savio Natural Beneficial Bacteria.™**

FUN OPTIONS FOR YOUR POND

The following projects are intended as enhancements to your Livingpond.™ In some instances additional materials may be required.

Rock the Liner

Disguising your pond liner is not necessary. EPDM liner is specifically designed for full sun exposure for decades. A natural layer of growth disguises liner within months. If you are inclined to disguise the liner follow the directions on this page for a Smooth Bottom Rock covering.

Old-style construction techniques favored loose rock piled on the liner. The result was expensive and laborious annual cleanings that compromised pond health and wasted water. A more effective technique is the **Smooth Bottom Rock** option which dresses liner without disrupting the pond's ecology or complicating maintenance.

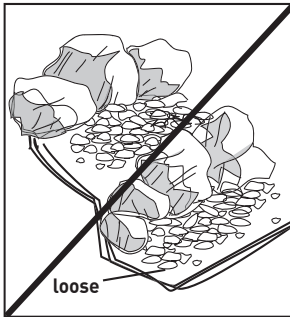

Loose rock traps debris, fosters anaerobic bacteria (which poses a threat to fish health) and can damage the pond liner. As debris accumulates, the only way to clean a loose rubble pond is by fully draining it, removing the fish and plants and then power washing the rocks.

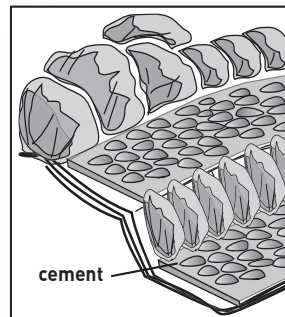

A smooth bottom pond makes waste removal easy and allows the pond to operate for decades without draining. The pond is able to achieve a stable natural balance that only comes with age. If desired, cement lined rocks can be run up the pond sides as well.

Smooth Bottom Rock Option

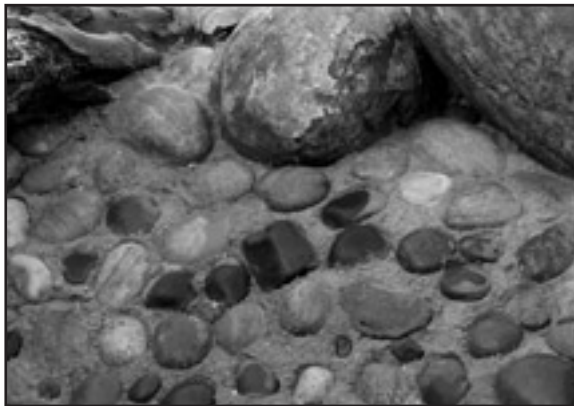

To create a safe, durable, easy-to-clean decorative rock bottom pond, press river stone halfway down into a fresh 2" layer of cement on the shelves. Build up and stabilize vertical stone walls with mortar.

New mortar will have a temporary adverse effect on water chemistry. Remedy this by acid-treating the mortar or using pH down prior to adding fish and plants. Your local pond supply dealer can recommend an appropriate treatment.

Before adding plants and fish, allow 3 days for pH to raise naturally to 7.0 or above, then add plants and/or fish.

ROCK THE LINER

Beach Option

A beach area breaks up the pond edge and also allows for greater interaction with fish.

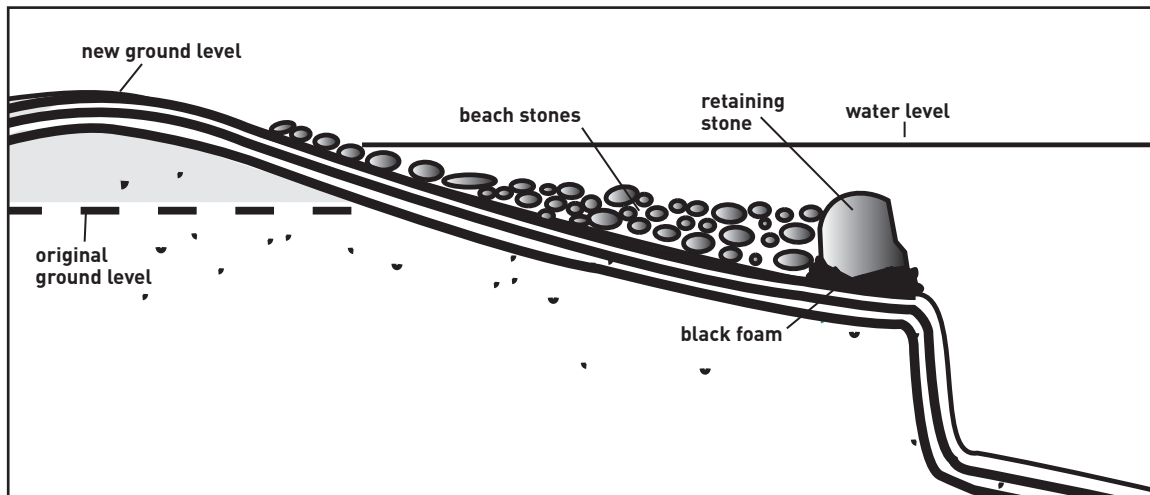

At the entry point of your pond, create a gradual sloping shelf. Place larger retaining stones at the edge of the shelf, 6" - 12" below water level. Secure the coping stones and fill the gaps between rocks with black foam. Backfill the area with 2" - 4" smooth river stones at least 2' out of the pond. To prevent water loss due to capillary action in the soil at the pond edge, extend the pond liner so it extends at least 2' out of the pond.



PATCH THE LINER

Fixing a puncture in EPDM liner is easy. Use the self adhesive cover included with your kit and follow the instructions below.



Clean Hole

Clean area around puncture so that it is free of dirt and debris. Use an abrasive pad to roughen a 1" circular area around the hole.

Cut Patch

Cut a round piece of patch from the self adhesive cover kit provided. Make the patch slightly smaller than the abraded area.



Apply Patch

Apply PVC primer to abraded area and allow to dry. Then remove backing from patch and apply. Smooth the patch and press firmly for 30 seconds.

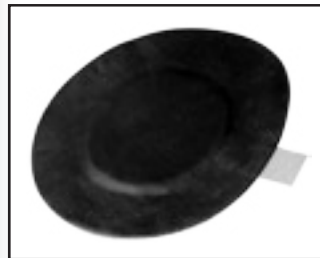

ACCESSORIES



16 Watt Ultraviolet Clarifier

The best way to clear green water. Aids in filtration and reduces the need for chemicals to control water clarity. (part no. SUV016)

8.5" faceplate

NOTES



TROUBLESHOOTING

Use this troubleshooting guide to determine common problems and remedies. See component instructions for more information.

SAVIO Compact Skimmerfilter™

Problem	Possible Causes	Remedies
Pump chamber runs dry during operation.	Low water level in pond. Weir door closed/stuck/obstructed Weir not large enough for pump flow.	Add water to pond. Water level should be between 3/4" above or below optimum water mark on faceplate. Ensure free movement of weir door/ remove obstruction. Reduce pump flow. Install smaller pump. Install larger weir assembly.
Water leak around faceplate.	Faceplate screws not tight. Faceplate not sealed properly.	Use #3 phillips screwdriver to hand tighten screws snugly. Remove weir face, clean liner of mud or gravel, smooth wrinkles. Reinstall.
Filter pad requires frequent cleaning.	Pump flow rate too high. Heavy waste load in pond due to fish, or plant debris.	Adjust pump flow rate to 2,500 gallons or less. Remove filter pad. Add a SAVIO Livingponds Filter.™
No debris collected by Skimmerfilter.™	Weir door closed/stuck/obstructed Pump is not functioning.	Ensure free movement of weir door/ remove obstruction. Check operation of the pump and pump screen (if equipped).

SAVIO Waterfall Weir™

Problem	Possible Causes	Remedies
Waterfall Weir™ weir chamber runs dry during operation	Low water level in pond. Pump inactive.	Add water to pond. Restart pump.
Water flows slowly from Waterfall Weir.™	Pump is turned off or obstructed. Feed line is obstructed.	Check pump operation. Remove any obstruction. Remove obstruction.
Filter media smells.	Filter mat needs cleaning.	Clean filter media. Add beneficial bacteria.

950 gph Pond Pump

Problem	Possible Causes	Remedies
No water flow from pump.	Pump is not plugged in. No power from GCFI outlet Pump is not priming.	Connect power plug. Verify power supply to GCFI outlet Verify pump inlet is submerged in water.
Low water flow from pump.	Debris blocking intake screen or impeller. Flow control valve (not included) set too low. Discharge pipe blocked.	Check screen and impeller for blockage and remove. Check and adjust flow control. Check and remove debris blocking discharge pipe.
Pump runs intermittently.	Thermal protection engaged.	Pump is too hot. Check that pump is fully submerged. Check inlet and discharge for clogs.

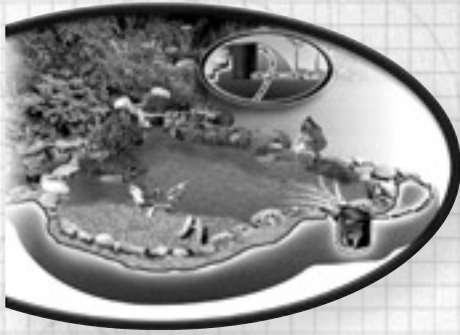

PP550

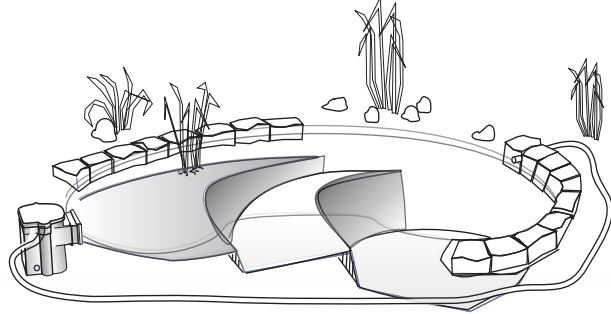

6' x 10' x 2' • 550 gal

Equipment Provided

Savio Compact Skimmerfilter™ Base Unit

●

Savio Waterfall Weir™

●

Savio Skimmerfilter™ Faceplate Assembly

6"

45 mil. EPDM Liner

10' x 15'

Underlayment

10' x 15'

Pond Pump 950 gph

●

Kink Free Hose

1" x 20'

Savio Black Foam 16 oz.

●

Pump Kit

●

Plumbing Kit

●

Tools Needed for Easy Installation

- shovel
- 4' hand level
- utility knife
- scissors

- wheelbarrow
- #3 phillips screwdriver
- flat bladed screwdriver
- 12' length 2 x 4/large straightedge

Rock To Secure Pond Edging

- 6' x 10' pond = 1 ton

Rock is usually sold by weight. Determining the amount of rock needed for pond edging can be highly variable depending upon the thickness and size of rocks to be used. Amounts given above are a general guideline and are based on rocks with average dimensions of 7.5" x 7.5" x 7.5".

**Your Pond
Dealer**