

# LIVINGPONDS™

Design & Construction Guide

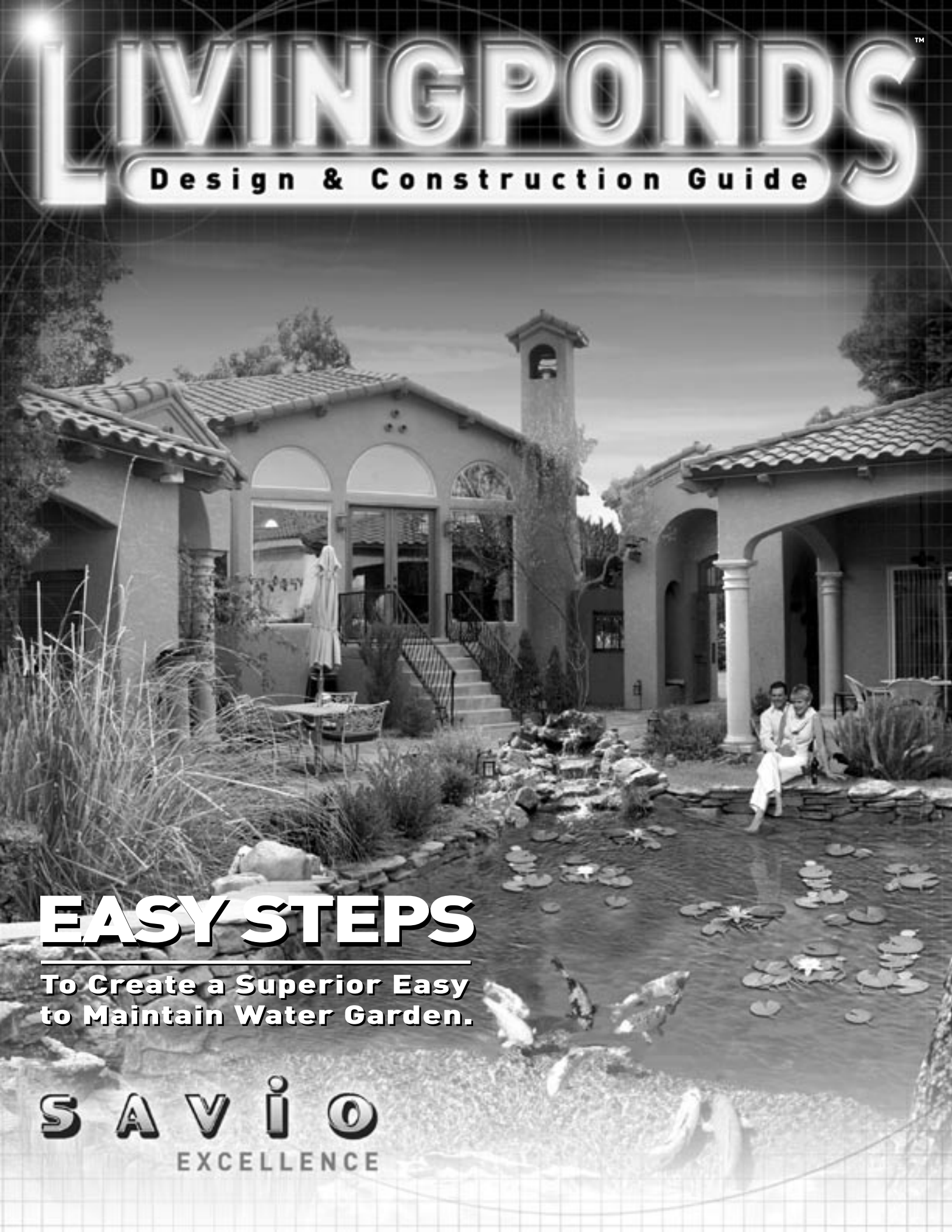

## **EASY STEPS**

**To Create a Superior Easy to Maintain Water Garden.**

**S A V I O**  
EXCELLENCE

## SAVIO LIVINGPONDS™

Savio Livingpond™ designs and equipment work in harmony to create low-maintenance, living water gardens that stay healthy with minimal effort. The equipment and the pond are designed with a philosophy that emphasizes low-maintenance combined with natural beauty. In no time you will have a backyard oasis to enjoy for many years to come.

### TABLE OF CONTENTS

<b>Welcome</b>	<b>3</b>	<b>Add Coping Stones</b>	<b>13</b>
<b>Choose a Location</b>	<b>4</b>	<b>Install Waterfall Weir™</b>	<b>14-15</b>
<b>Level the Site</b>	<b>5</b>	<b>Attach Liner to Filter</b>	<b>16</b>
<b>Measurements</b>	<b>6</b>	<b>Install Skimmerfilter™</b>	<b>17-19</b>
<b>Mark Outlines</b>	<b>7</b>	<b>Attach Pump</b>	<b>20</b>
<b>Place Equipment</b>	<b>8</b>	<b>Finishing Up</b>	<b>21-22</b>
<b>Connect Livingponds Filter™</b>	<b>9</b>	<b>Maintain</b>	<b>23-25</b>
<b>Bury Filter</b>	<b>10</b>	<b>Options</b>	<b>26-29</b>
<b>Dig Levels</b>	<b>11</b>	<b>Accessories</b>	<b>30</b>
<b>Add Underlayment &amp; Liner</b>	<b>12</b>	<b>Troubleshooting</b>	<b>31</b>

**SAVIO**  
ENGINEERING

## WELCOME

**Dear Pond Builder,**

If you are new to water gardening you are about to embark on a voyage of discovery. Owning a pond is a rich and rewarding experience and SAVIO makes it easy.

If you are an experienced pond builder you may find we do things a bit differently, so we suggest that you take the time to review this guide in its entirety before starting.

Our goal is to help you to create ponds that look great and require minimal effort to maintain. The SAVIO equipment, the construction, even the design of the pond is formulated to give you the maximum amount of satisfaction with the least amount of work.

The best pond designs mimic nature. By encouraging a naturally balanced living system your pond will provide you with years of enjoyment. SAVIO Livingponds™ does not require aggressive cleaning, annual draining or excessive chemical treatments. This means less work and more enjoyment for you and your family.

*Your friends at SAVIO wish you the best.*

**REMINDER: Read through the entire design and construction guide before starting.**

SAVIO  
ENGINEERING

**TOOLS**

***Gather necessary equipment prior to installation.***

- shovel
- 4' hand level
- utility knife
- string level, site or transit level (recommended)
- wheelbarrow
- #3 phillips screwdriver
- large channel-lock wrench

## STEP 1 – CHOOSE A LOCATION

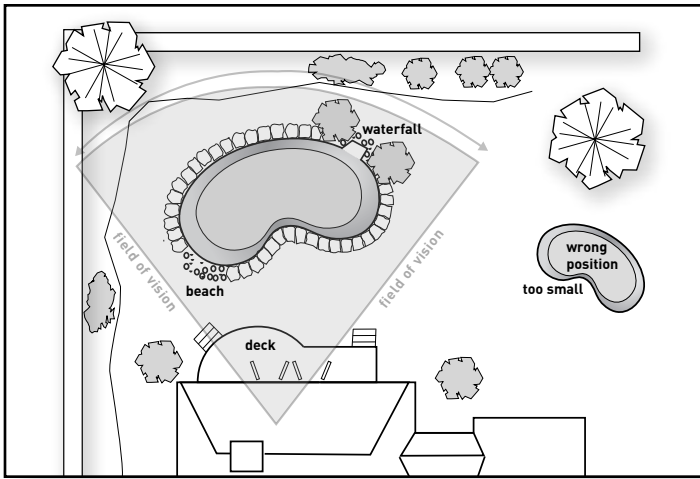

### Pick a Location

Choosing a location is the first step toward building your pond. Locate the pond for easy access and viewing from your home. The ideal placement allows the pond to be a part of everyday living. Make it the focal point so that it dominates the viewing area. Enjoy your pond from the kitchen, your living room or upstairs deck. Place it to receive ample summer and winter sun and avoid putting it under pine or fruit bearing trees.

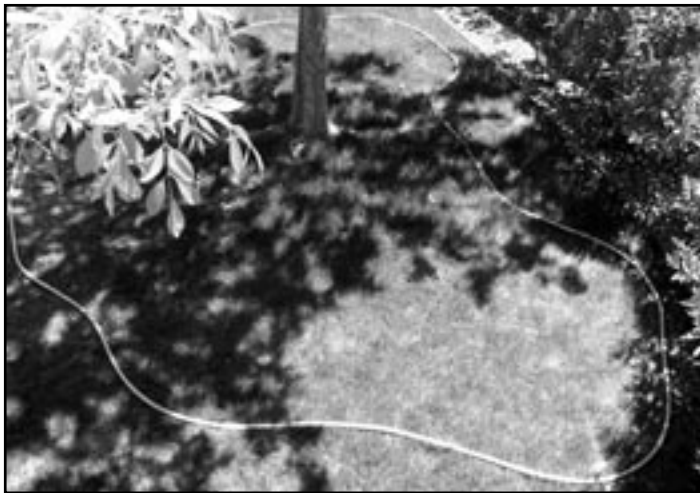

### Outline Pond Shape

Use a garden hose to outline the pond shape. An open, gradually curving design such as a bean or kidney shape encourages better circulation and pond health.

### TIP:

Avoid eccentric shapes, sharp curves and niches. They trap debris, cause excessive liner folds and create stagnant water.

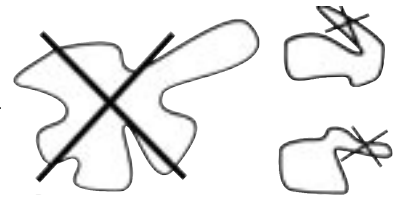

### Assemble Components

Unpack and assemble Skimmerfilter™ and Livingponds™ Filter using the instructions provided with each unit.

## STEP 2 – LEVEL THE SITE

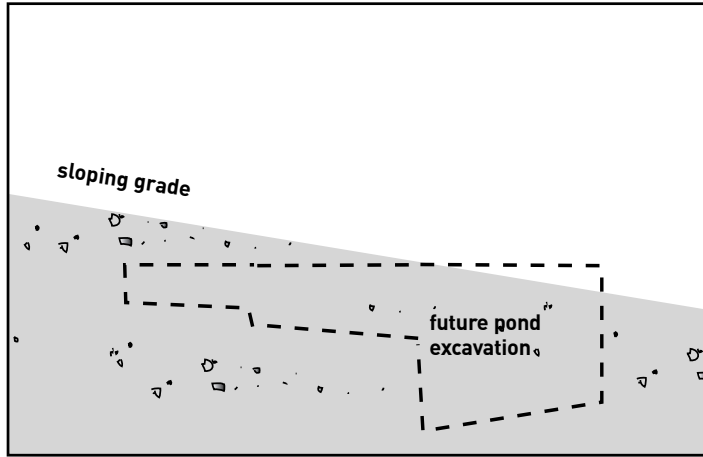

### Level the Site

Careful attention to site levelling will create a more professional looking finished product and make the installation process easier. Prior to excavation, the pond site must be leveled on all sides. If you do not have access to a transit (site level), an inexpensive line level can be found at any hardware store.

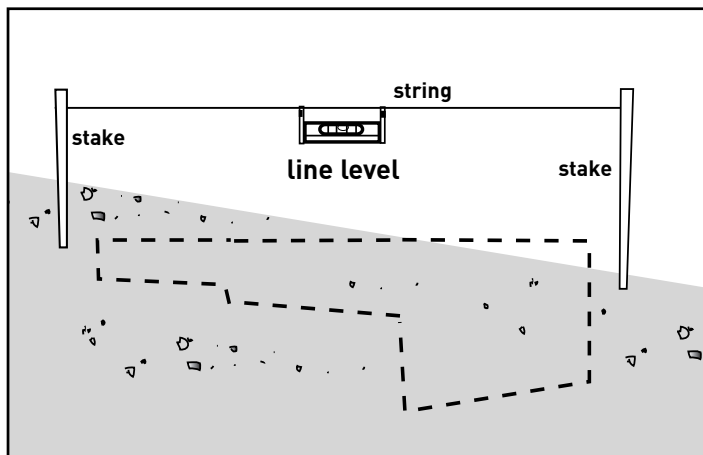

### Setting the Level

Place two stakes at opposite sides of the pond. Attach a string to the stake on the highest side of the site 6" above ground level. Pull the line tight and level across the area to the other stake. Place the line level in the center of the string and adjust the low side until the bubble is centered within the line level.

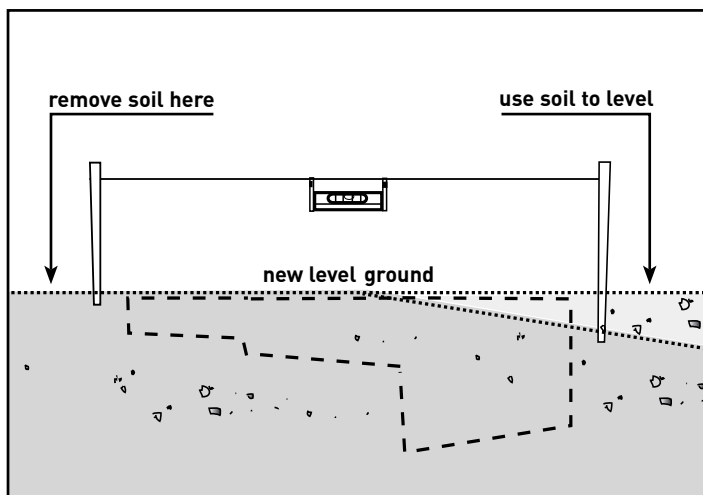

### Add / Remove Soil

Add or remove dirt until the ground level measures the same uniform distance along the length of the string. Repeat the leveling procedure on all sides using the original stake as your reference point.

## STEP 3 – MEASUREMENTS

Select the your SAViO Pond Package™ below to determine the correct excavation dimensions for your pond.

**deepest level**  
40% of the overall surface area of the pond. Provides a basin of cooler water for fish in summer and serves as a collection area for landscape debris & waste. Slope this level to a point so that debris will collect in one specific area. (Depth 24")

**mid level**  
20-30% of the pond surface area. Slope downward slightly (~5°) toward the bottom of the pond. (Depth 15")

**shallow level**  
20-30% of the pond surface area. Use for planting areas. Slope downward slightly (~5°) toward the bottom of the pond. (Depth 10")

**coping shelf**  
6" to 8" wide margin reserved for rockwork that holds the edges of the pond in place. (Depth 6")

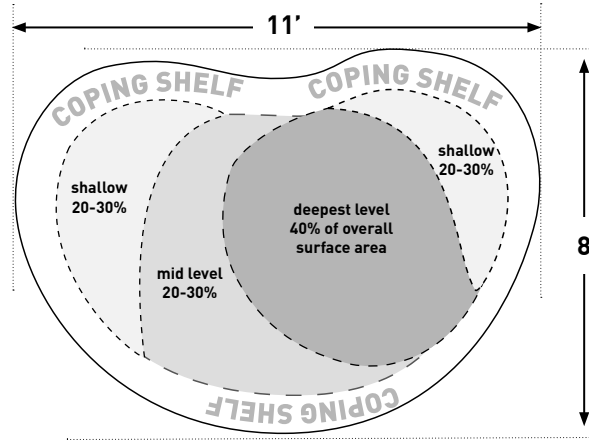

### 800 gallons

Outside dimensions: 8' x 11'

Coping Shelf: 6" deep  
Shallow area: 10" deep  
Mid Level : 15" deep  
Deep area: 24" deep

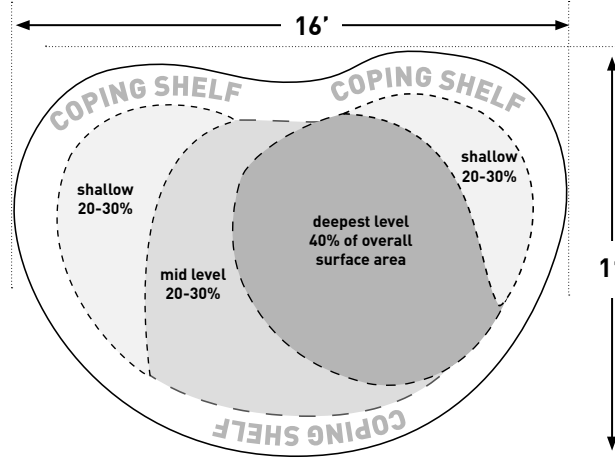

### 1500 gallons

Outside dimensions: 11' x 16'

Coping Shelf: 6" deep  
Shallow area: 10" deep  
Mid Level : 15" deep  
Deep area: 24" deep

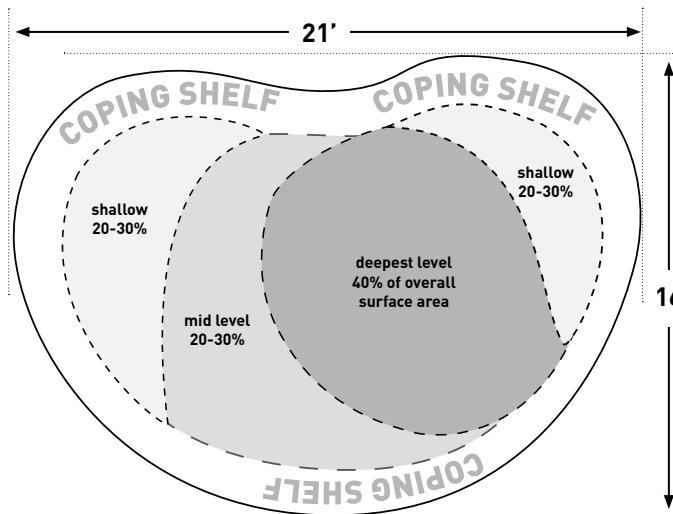

### 3000 gallons

Outside dimensions: 16' x 21'

Coping Shelf: 6" deep  
Shallow area: 10" deep  
Mid Level : 15" deep  
Deep area: 24" deep

**STEP 4 – MARK OUTLINES****Mark Pond Outline**

Once the site has been leveled and the equipment has been placed, re-draw the outline of the pond. Marking the overall pond shape and shelf locations with spray paint prior to excavation will help guide the digging process and ensure that the pond stays within the limits of the Savio Pond Package.

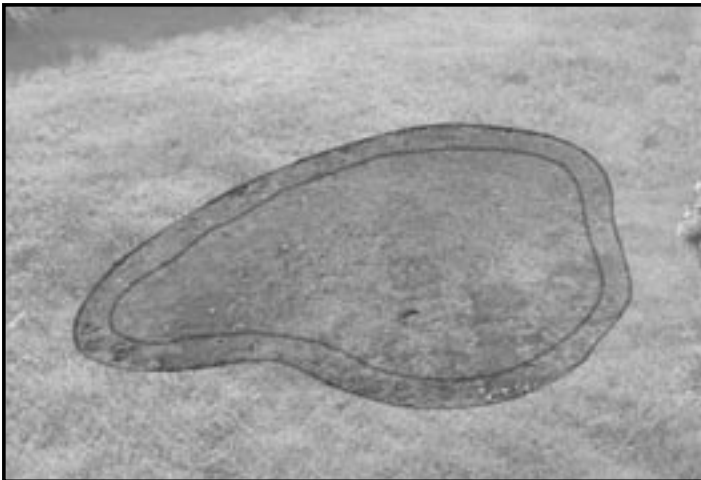
**Mark Coping Shelf**

Once the outline has been marked, create another outline 6" into the pond for the coping shelf - a transitional area where pond and landscaping meet.

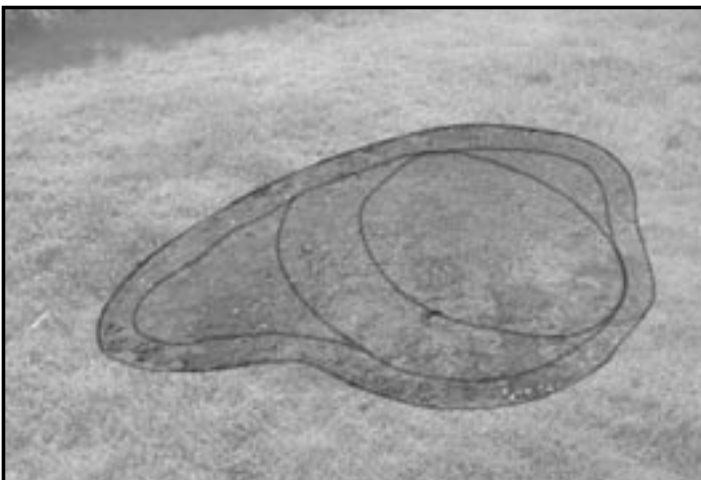
**Mark Depth Shelves**

Using the diagram on page 6 mark the locations of each of the remaining levels of the pond: shallow, mid-level and deep area.

## STEP 5 – PLACE EQUIPMENT

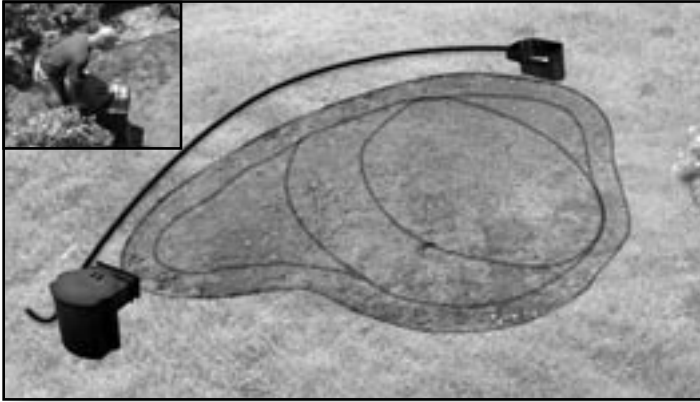

Pond with Skimmerfilter™ and Waterfall Weir.™

### Locate Equipment For Pond Package 800

Position the Skimmerfilter™ and Kink Free Hose™ prior to excavation. Place the Skimmerfilter™ on the side of the pond closest to the viewing area. Lay hose along ground so that it discharges into the far side of the pond.

This provides the best view, encourages good circulation, simplifies maintenance and hides the face of the Skimmerfilter.™

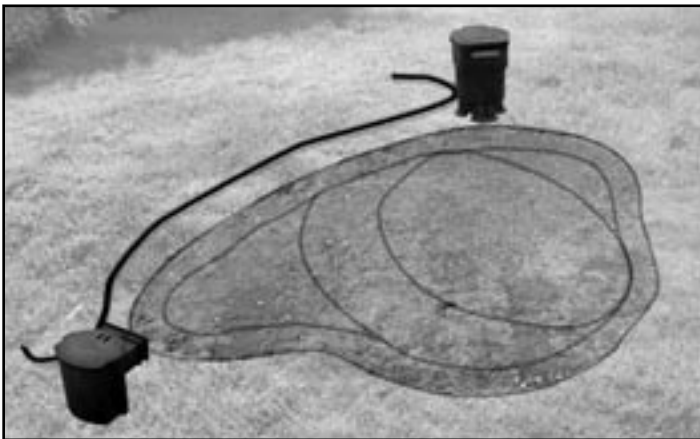

Pond with Skimmerfilter™ and Livingponds filter.™

### Locate Equipment For Pond Packages 1500 and 3000

Position the Skimmerfilter,™ Livingponds Filter™ and Kink Free Hose™ prior to excavation to ensure proper placement of the equipment. Place the Savio Skimmerfilter™ closest to the viewing area. Place the Livingponds Filter™ opposite the Skimmerfilter™ facing the viewing area.

This provides the best view, encourages good circulation, simplifies maintenance and hides the face of the Skimmerfilter.™



## TIP:

Positioning the Skimmerfilter™ on the downwind side of the pond will aid in the effective collection of floating debris. This is less important than placing the Skimmerfilter™ opposite the waterfall but it is a significant design consideration.



## STEP 6 – CONNECT THE LIVINGPONDS FILTER™ (for pond packages 1500 & 3000)

Prevention of leaks in pond installation begins with proper component assembly. Remember that once your equipment is buried it can be difficult and time consuming to fix faulty connections.

### Livingponds Filter™ Installation - Pond Packages 1500 and 3000



1 Apply teflon tape to threads on 90° elbow and male insert.

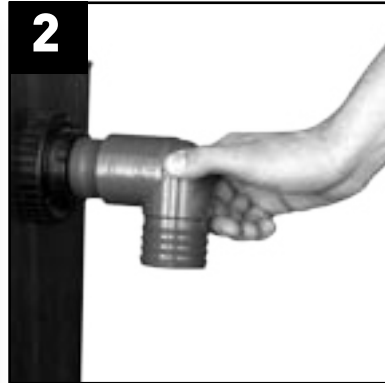

2 At the top of the filter insert 90° elbow.

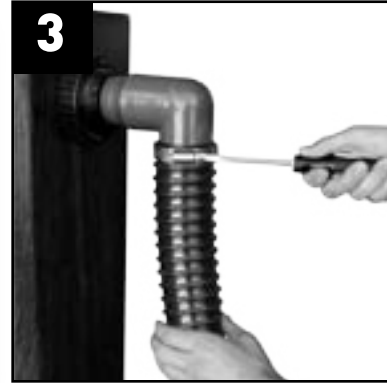

3 Attach hose and tighten clamp.



4 At the bottom of the filter insert male adapter.



5 Attach hose and tighten clamp.

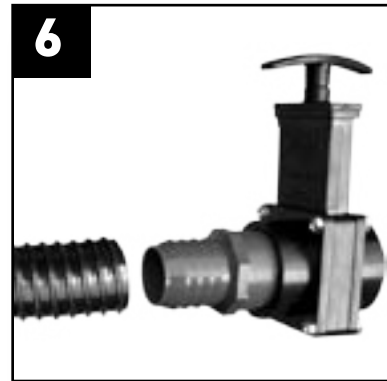

6 Attach to hose to bottom drain.



7 Tighten hose clamp.



8 Assembled filter with bottom drain connection.



9 Close the knife valve. Fill the filter halfway with water. Check for leaks.

## STEP 6 – BURY FILTER

10

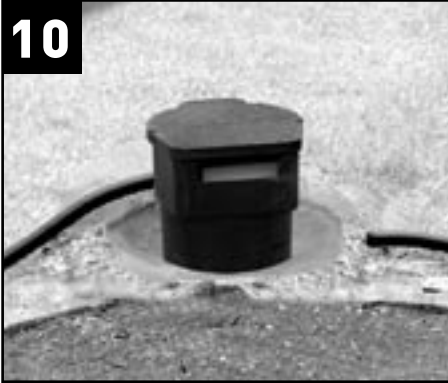

Drain filter before proceeding. Place filter in previously determined site prior to excavation. Bury in position to a depth of 12". As the digging proceeds the excavated soil will be piled around the filter to create the waterfall and stream foundations.

11



Check level front to back and side to side.

### OPTION:

See page 28 for a description of a more elaborate waterfall installation.

12

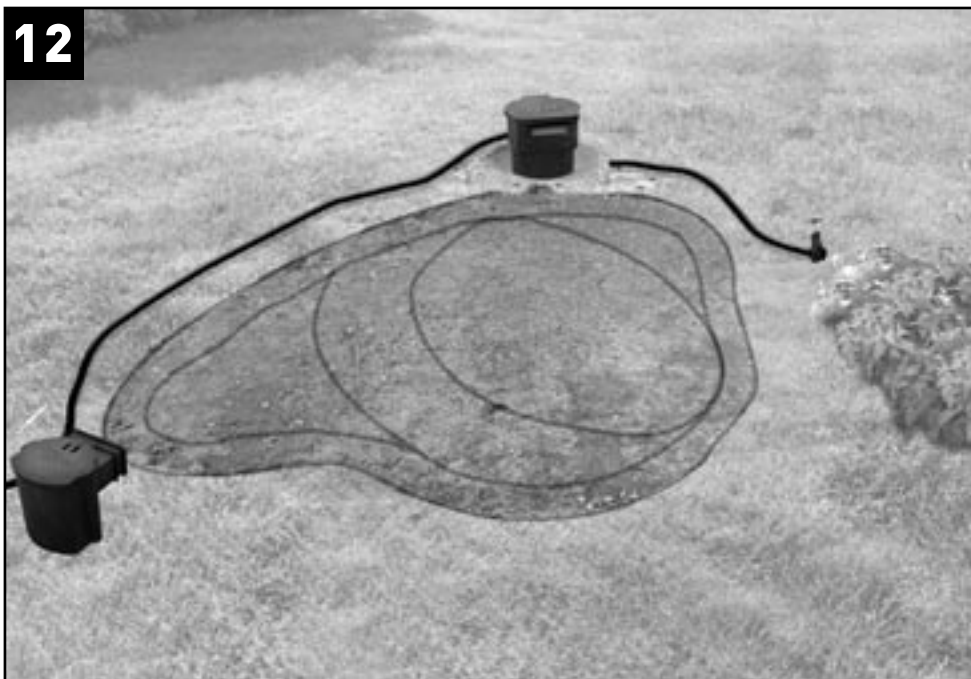

Direct filter drain hose to drainage area. Slope it so water will flow freely during filter cleanings.

### TIP:

Utilize the nutrient rich water from filter cleanings to water nearby plants, shrubs or trees by extending filter drain to these areas.

## STEP 7 – DIG LEVELS



### Dig 1st Level

Once the ground has been leveled on all sides, dig the pond to a depth of 6" to create the coping shelf level.



**Warning!** Before undertaking any excavation project, always check first with your local utility company for the presence of underground wires, water and gas lines.



### Dig Shallow and Mid Levels

Excavate the shallow areas of the pond to a depth of 10" and the mid-level of the pond to a depth of 15". **Gently slope shelves** (~5") toward the lowest point of the lower basin for easiest cleaning. Set aside excavated soil to build the waterfall runway, place the rest 2' away from the outer edge of the pond to use as backfill for the coping shelf.



### Dig Deepest Level

Excavate the deepest level of the pond to a depth of 24". **Make the pond sides nearly vertical.** A 60°-75° drop encourages debris to settle to the pond bottom, discourages predators and makes access for maintenance easy. Slope the deepest level to one point to make it easy to collect debris later on. Double check measurements for all levels. When the excavation is complete check for sharp rocks or roots that may damage the pond liner and remove if necessary.

## STEP 8 – ADD UNDERLAYMENT AND LINER



### Place Underlayment

Once excavation is complete it is time to create the containment that will hold the water and act as the foundation for your Livingpond.™ Underlayment protects and extends the life of the liner. Cut protective felt underlayment into overlapping pieces to cover the entire pond site. Start from the bottom of the pond and work outward, smoothing wrinkles and folds along the bottom and sides.



### Place Liner

With one piece of liner cover the underlayment. Center the liner so a roughly equal amount remains on all sides of the excavation. Work from the bottom and sides outward, smoothing out wrinkles and folds

(BE CAREFUL: Rocks wedged in shoe treads can damage liner). **DO NOT TRIM LINER AT THIS TIME.**



### Place Rock

Place rocks at several points to hold liner and underlayment in place.

### TIP:

In case you puncture the EPDM liner, we've included a self-adhesive patch with your kit. For instructions, see **How to patch liner** on page 29.

## STEP 9 – ADD COPING STONES



### Place Coping Stones

Secure underlayment and liner by adding coping stones. Set coping stones on top of the liner around the edge of the pond. Leave the area in front of the Skimmerfilter™ and the Livingponds Waterfall Filter™ free of rockwork for now.

Coping stones secure and hide liner at the pond's edge. Use flat bottom rocks, roughly 6" - 7" in height.

To avoid leaks be careful during installation not to drop rocks or place any sharp edges against the liner. Use underlayment scraps under rockwork for added protection of the liner.



### Backfill Coping

When the coping stones are in place, flip the extra liner over the back of the stones and backfill to create the coping shelf around the pond. The reason for this coping shelf is twofold: it disguises and secures the liner while creating a slight elevation around the pond to prevent unwanted landscaping debris from washing into the system.

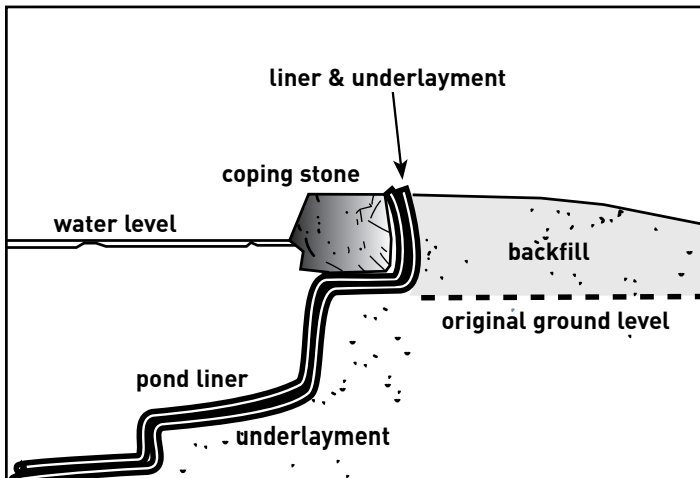

### Coping Shelf

The diagram at left shows a cross-section of the coping shelf.

## STEP 10(A) – INSTALL WATERFALL WEIR™ (for pond package 800)



**WATERFALL WEIR™**  
(pond package 800 only)



**1** Level the soil in the area where the assembly is to be placed. Use blocks to add height to the waterfall.



**2** Connect hose to back of Waterfall Weir™ and tighten with hose clamp.



**3** Place the Waterfall Weir™ and level the unit front to back and side to side.



**4** Place liner over the face of the waterfall. Leave a moderate amount of slack in the material.



**5** Mark position of the weir opening by rubbing the liner with a hard object such as a screwdriver or a blunt scissor edge.



**6** Cut away the liner to the shape of the opening.



**7** Attach liner bracket and liner to waterfall weir by installing 4 tack screws **halfway** into each corner. (Front of bracket has recessed screw holes.)



**8** Next, install the remaining screws halfway. Tighten all screws evenly **by hand**, until flush with the faceplate.



**9**  
Use rockwork to create interesting drops and cascades. A few buckets of water may be useful for discovering the best layout.



**10**  
The final result with rockwork in place. Note: the rock running up the sides of the waterfall will be backfilled to hide the liner later on.



**11**  
Black foam fills voids in the rockwork and forces water to run over the rocks instead of beneath and between them.



**12**  
Place filter media pad into the waterfall weir.



**13**  
Fill the mesh bag with rocks for ballast. Use large gravel, lava rock or stones.



**14**  
Place mesh bag on top of media.

## STEP 10(B) – ATTACH LINER TO FILTER

(for pond packages 1500 & 3000)



**1** Pull liner over the face of the Livingponds Filter.<sup>™</sup> Cut liner to shape of opening, as shown.



**2** Slide waterfall weir into place. Ensure that the weir seal is firmly compressed between the weir and filter chamber, with flat side of seal facing toward the filter body.



**3** Insert and gently tighten the four large sheet metal screws into the holes in the waterfall weir. Do not over tighten.

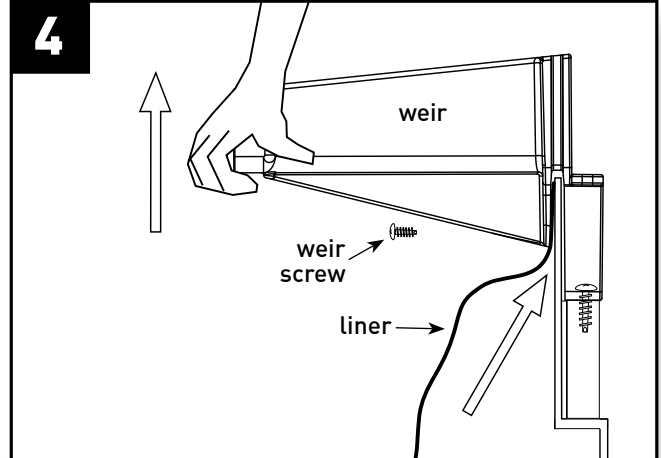

**4** Gently lift weir front. Then slide liner between filter and bottom weir supports. Carefully secure the liner to the Livingponds Filter<sup>™</sup> to maintain a water-tight transition between the filter and waterfall.



## STEP 11 – INSTALL SKIMMERFILTER™

One of the most crucial steps is installing the Skimmerfilter.™ For best results carefully follow the steps below.



Fill the pond using a garden hose. This will allow you to accurately determine water level on all sides before proceeding with installation of the Skimmerfilter.™ Water level should hit partway up the coping stones. Verify that the water level is a few inches below the edge of the liner on all sides.



With the pond full, mark position of water level on the liner at the Skimmerfilter.™ location with white chalk.



Partially drain pond 8"-10" inches.

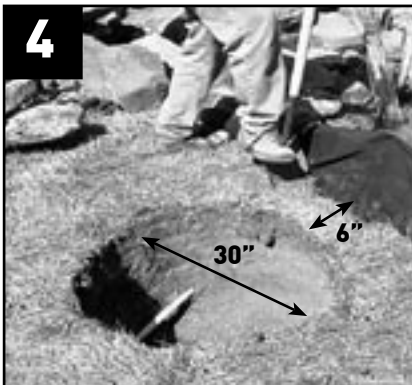

6" back from the coping shelf, dig a round hole measuring 30" across, with a depth of 17" below the marked water line. Dig the front of the hole ¼" deeper than the back to compensate for settling.



Dig a channel 7" below the water line, measuring 24" wide, from the hole to the pond. The Skimmerfilter.™ neck rests on this channel. Compact and level the bottom of excavation. Do not dig too deeply or the soil may settle unevenly.



Place the Skimmerfilter.™ in the hole. Check to make sure the intended water level meets the skimmer ¾ inches below the top of the neck. Adjust up or down by adding or removing dirt.

## STEP 11 – INSTALL SKIMMERFILTER™ (continued)



Verify that the face of the Skimmerfilter™ is flush with the back wall of the lined coping shelf. Adjust placement, if necessary.



Level the unit front to back and side to side. Make the front edge  $\frac{1}{4}$ " lower than the back edge. **Check water level once again.**



Backfill around the Skimmerfilter™ with the lid in place. Use moist sand or pea gravel or, if unavailable, gravel and loose soil (free from clumps). Hand pack every two or three inches. Do not over compact. Lightly moisten the backfill to aid in settling.



Dig a trench for the Kink Free Hose.™ Use the side closest to your water return. Extend this trench so that it connects to the waterfall filter.

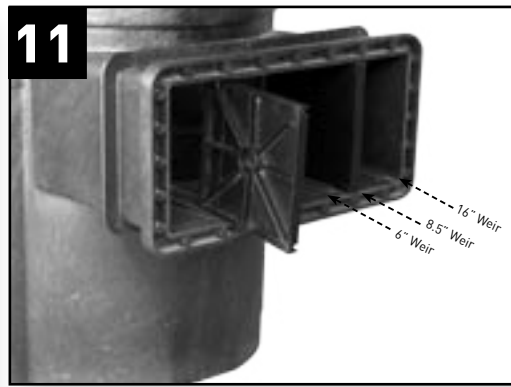

Insert weir dividers into Skimmerfilter™ neck. Use the tracks which correspond with the faceplate provided with your kit, as shown in the picture above. (8' x 11' pond uses innermost tracks / 11' x 16' and 16' x 21' use middle tracks)

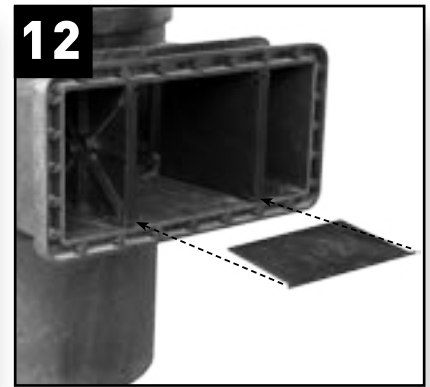

Push the weir door hinge tabs into notches on the weir dividers, using thumbs to hold tabs secure. Lay the door horizontal in the Skimmerfilter™ neck.



**13** Position pond liner over the Skimmerfilter™ mouth and hold it in place. Smooth liner free of wrinkles and folds. Wipe clean.



**14** Select two locator pins from the screw packet provided.

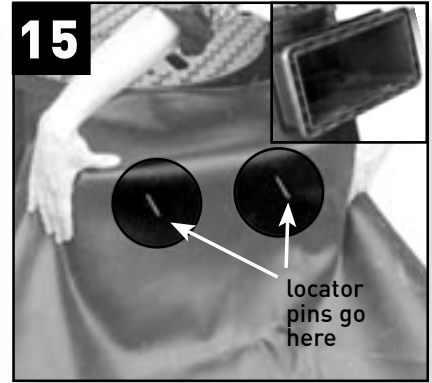

**15** Insert the locator pins through liner into the holes indicated above.



**16** **A)** Make a 3" wide incision through the centered liner  $\frac{3}{4}$ " below the top of the Skimmerfilter™ opening.  
**B)** Slide the faceplate over the locator pins to align the screw holes.



**17** Use a #3 phillips head screwdriver to install screws halfway into all four corners. Install the remaining screws halfway. Tighten top, bottom and sides alternately *by hand* until screw heads are flush to create a watertight seal.



**18** After the faceplate is properly tightened use a knife to trim the liner inside the mouth of the Skimmerfilter™.



**19** Hide the Skimmerfilter™ from view by extending the coping shelf rockwork to both sides of the Skimmerfilter™ opening.



**20** Place a flat rock over the Skimmerfilter™ neck to camouflage.

## TIP:

### Leave Skimming Access

Do not to block the opening of the Skimmerfilter™ with rockwork or with plants. Leave it open to successfully pull debris from the pond surface. An easily removable faux rock or potted plant can be used to hide the Skimmerfilter™ lid from view.

## STEP 12 – ATTACH PUMP



1 Slide hose through pre-cut hole in Skimmerfilter.™



2 Cut to length leaving 12" of excess Kink Free Hose™ inside the Skimmerfilter.™

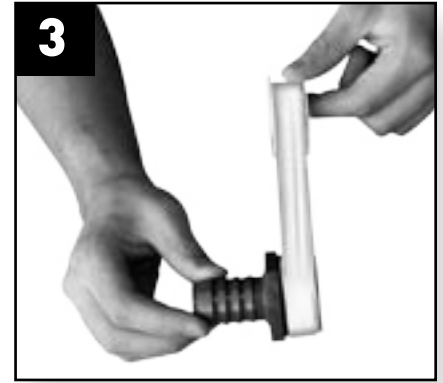

3 Put teflon tape onto pump connector threaded fitting.



4 Put teflon tape onto 90° elbow.

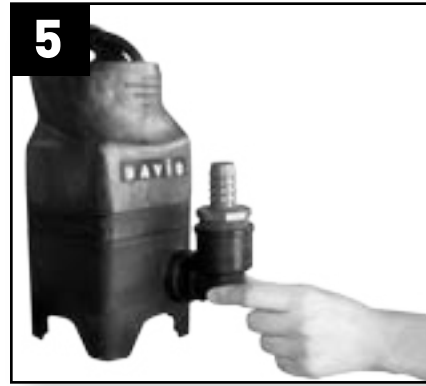

5 Attach assembly to pump.



6 Attach hose and tighten hose clamp as shown.



7 Lower pump into Skimmerfilter™ chamber



8 Use backfill dirt to hide the Kink Free Hose.™

## FINISHING UP



Fill the pond with water and check for leaks. Initially the pond may be cloudy from the accumulated debris of rockwork and dust. Over the course of a few days this debris will settle and the pond will gradually clear.



To start the filtration system, simply plug in the pump.



With the pond filled the weight of water will cause the liner to settle. Liner can be trimmed and hidden in the backfill at this time. Do not allow soil to contact water.



Establish the ecosystem for plants and fish by adding Savio Natural Beneficial Bacteria.™ See Maintenance pg 24 for more information on water treatments.



The creation of a professional looking installation hinges on the finishing touches. Add terrestrial plants and other landscaping to soften the edges of the pond and integrate it into the surrounding landscape. Within the pond, use marginal and aquatic plants for bog areas and the interior of the pond. Aquatic plants come in many shapes and varieties. A trip to a pond specialty retailer or local nursery will yield a wealth of possibilities. See page 26 for more details on creating bog areas.



It's best to add only a few small fish at first and then wait a few weeks for the pond to establish. Consult your local pet shop or pond store for advice on selecting fish and stocking capacities.

## THE END RESULT



**At last!** All your hard work has finally paid off and you have a beautiful backyard paradise to enjoy for years to come. You'll enjoy the easy maintenance and superior water quality only a pond built with Savio products can provide.

### Send Us Your Pictures



Take a photo and send it to us at: [pondstories@savio.cc](mailto:pondstories@savio.cc). We'd love to share your success on our website.

## CARING FOR YOUR LIVINGPOND™

Keeping your pond looking beautiful is easy with Savio equipment. The next few pages offer helpful tips on how to keep your pond looking its best in all seasons.



### Remove Debris

Check and **remove debris captured in the Skimmerfilter™ leaf basket** every week or as needed. The frequency required will vary seasonally, with cleaning required more often in the Fall than at other times.



### Clean Filter Media

**Clean the filter media** when the flow rate slows or becomes clogged with debris. Excessive cleaning kills the beneficial bacteria that reside on the filter media.

Gently agitate filter media to dislodge unwanted debris, then open bottom drain valve to flush it out. Cleaning schedule: every 6-8 weeks.

**Do not use chlorinated water, hot water, soaps or chemicals on any filter media.** If you remove the media from the filter use clean water from the pond to rinse and do not allow the media to dry out during cleaning.

After cleaning the filter, add more **Savio Natural Beneficial Bacteria™** to the Skimmerfilter™ and Livingponds Filter.™



### Clean Filter Mat

Inspect and **clean the filter mat** (Skimmerfilter,™ Livingponds filter™ & Waterfall Weir™) once a week or as needed. The filter mat can be cleaned when it appears dirty by rinsing it in a bucket of clean pond water. Avoid using untreated tap water or harsh scrubbing as this can damage the colonies of beneficial bacteria growing on the filter mat.

## CARING FOR YOUR LIVINGPOND™



### Cleaning the Pond Bottom

A **long handled leaf rake net** belongs on the list of necessary equipment for every pond owner. Use it to scoop settled debris out of the deepest point in the pond.



### Add Bacteria

The secret to good water quality is filtration, and good filtration relies on beneficial bacteria. These naturally occurring microscopic organisms live on filter media and submerged pond surfaces. **Add Savio Natural Beneficial Bacteria™ to reduce maintenance and improve pond health.** It breaks down organic sludge and debris and balances pond chemistry. Use it throughout the season and in particular when establishing a new pond, prior to adding fish, after pond cleaning and when feeding heavily during summer months.

### Winter Equipment Care

Although outdoor ponds can run all winter, most do better when shut down or with the flow rate substantially reduced. Prepare ponds for winter in mid-to-late November, or when ice persistently develops on the surface of the pond.

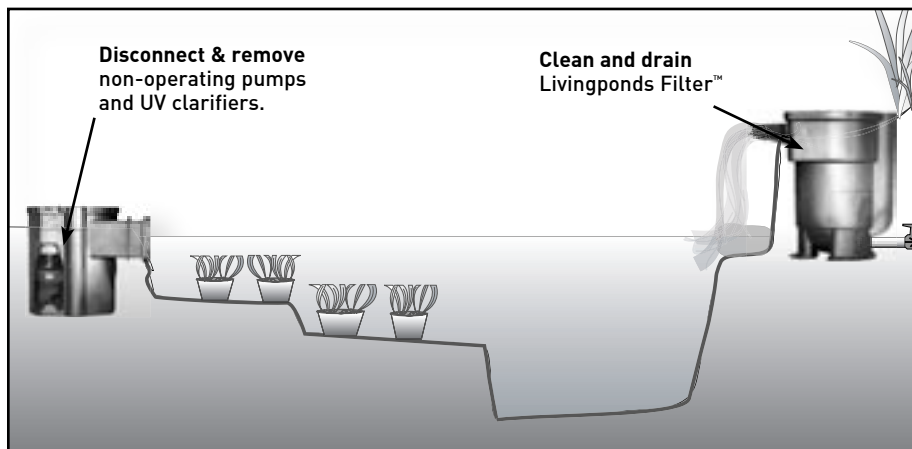

Remove, drain, clean and store the pump in an area that will not freeze. Drain the Livingponds Filter™ and the Skimmerfilter™ at this time. To avoid freeze damage, disconnect the UV filter and store it indoors.

If fish are present it is important in Fall to remove sludge and organic debris (dead leaves, grass, fish waste and algae). Connect an aerator

and de-icer to guarantee a healthy supply of oxygen and allow the exchange of other gases throughout the winter.



## MAINTAIN WATER QUALITY

Below are some of the most common challenges for maintaining water clarity: **Hair and string algae**, stringy masses of green material that cling to rocks and liner. **Planktonic algae**, a single-cell organism that gives water a green, soupy cast. **Organic debris**, fish waste and the by products of a living pond that in high concentrations can pose health problems to fish. **Avoid using harmful chemicals that can harm the environment and the pond eco-system.**



### Hair & String Algae

Long, stringy or clumpy algae is referred to as hair algae (aka blanket weed, string algae, beard algae). A small amount of hair algae on underwater surfaces is beneficial to pond health. Add **Savio Natural Barley Extract™** or **Savio Greenex® Micro Granules™** to create a healthy pond balance, which, in turn, curtails the over development of hair algae.



### Planktonic Algae

Phytoplankton or planktonic algae are present in even the clearest water but can become a problem when their numbers increase to the point that water becomes green and soupy. This phenomenon when it develops suddenly is known as "algae bloom". Use **Savio Natural Beneficial Bacteria™** and **UV Clarifier** to treat planktonic algae.

### UV Clarifiers

Add a **Savio UV Clarifier™** to decrease the workload of the biological filter, reduce maintenance and give water a crystal clear appearance. If using an ultraviolet clarifier, turn it off for 24 hours when adding beneficial bacteria. This gives bacteria the opportunity to settle and attach to filter media and pond surfaces. Replace UV bulbs annually for best performance.



### Organic Debris

Heavy amounts of decomposing organic debris, fish waste and excessive fish food can pose health problems to fish. Evaporation leaves behind impurities, such as minerals and salts, which can become detrimental. Throughout the season perform **small, partial water changes**. Remove 15% - 20% of the water every 20 to 30 days. Never change more than 1/3 of the water at one time. Discharge the nutrient rich water onto surrounding landscape. Refill the pond and add water conditioner and **Savio Natural Beneficial Bacteria.™**

## FUN OPTIONS FOR YOUR POND

The following projects are intended as enhancements to your Livingpond.™ In some instances additional materials may be required.

### Planting Bog Option

Bog plants grow on the outer edges of ponds and thrive in moist soil or shallow water. A contained area for bog plants allows them healthy growth while preventing them from overtaking the entire pond.

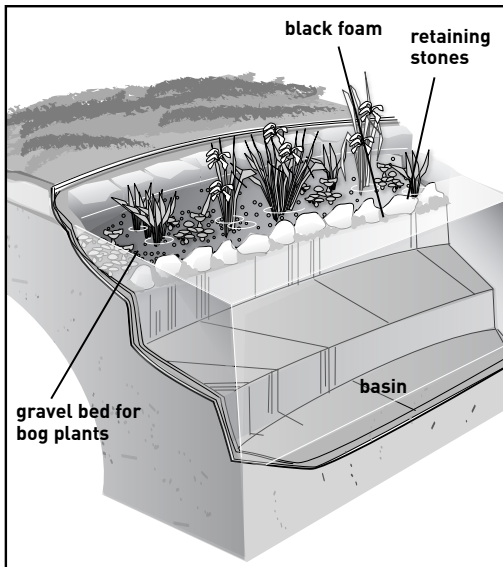

### It's Easy to Build

Use retaining stones to border your shallow shelf. Use black foam to fill between the stone. Add 4" to 6" of ¾" - 1½" rounded gravel in the bed. Place the plants directly into the gravel bed.

### Beach Option

A beach area breaks up the pond edge and also allows for greater interaction with fish.

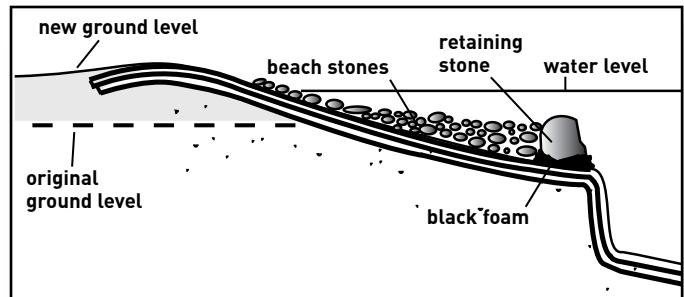

At the entry point of your pond, create a gradual sloping shelf. Place larger retaining stones at the edge of the shelf, 6" - 12" below water level. Secure the coping stones and fill the gaps between rocks with black foam. Backfill the area with 2" - 4" smooth river stones at least 2' out of the pond. To prevent water loss due to capillary action in the soil at the pond edge, extend the pond liner so it extends at least 2' out of the pond.



## ROCK THE LINER

Disguising your pond liner is not necessary. EPDM liner is specifically designed to handle full sun exposure for decades. A natural layer of growth disguises liner within months. If you are inclined to disguise the liner follow the directions on this page for a Smooth Rock Bottom covering.

### Rock the Liner

Old-style construction techniques favored loose rock piled on the liner. The result was expensive and laborious annual cleanings that compromised pond health and wasted water. A more effective technique is the **Smooth Bottom Rock** option which dresses liner without disrupting the pond's ecology or complicating maintenance.

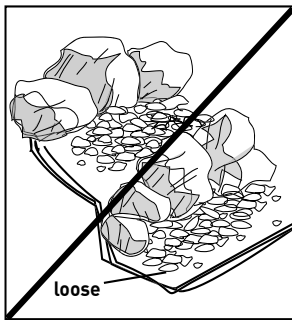

Loose rock traps debris, fosters anaerobic bacteria (which poses a threat to fish health) and can damage the pond liner. As debris accumulates, the only way to clean a loose rubble pond is by fully draining it, removing the fish and plants, and then power washing the rocks.

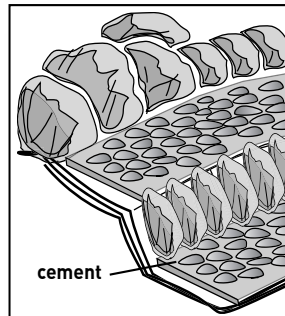

A smooth bottom pond makes waste removal easy and allows the pond to operate for decades without draining. The pond is able to achieve a stable natural balance that only comes with age. If desired, cement lined rocks can be run up the pond sides as well.

### Smooth Bottom Rock Option

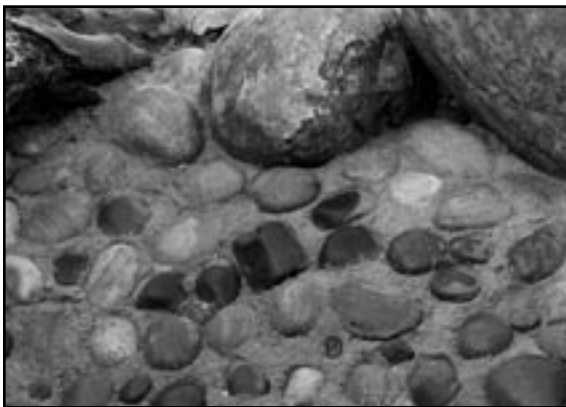

To create a safe, durable, easy-to-clean decorative rock bottom pond, press river stone halfway down into a fresh 2" layer of cement on the shelves. Build up and stabilize vertical stone walls with mortar.

New mortar will have a temporary adverse effect on water chemistry. Remedy this by acid-treating the mortar or using pH down prior to adding fish and plants. Your local pond supply dealer can recommend an appropriate treatment.

Before adding plants and fish, allow 3 days for pH to raise naturally to 7.0 or above, then add plants and/or fish.

## WATERFALL AND STREAM OPTION

With the purchase of additional underlayment and EPDM Liner you can enhance your water feature with a dramatic waterfall or stream.



**1** Level the soil in the area where the filter is to be placed. Use blocks to add height to the waterfall. Place filter and level the unit front to back and side to side.



**2** Use soil excavated from the pond to create a runway for the waterfall. A retaining wall of blocks can be used to provide shape and underlying structure.



**3** Place down underlayment and liner. Position rockwork to create drops and cascades.

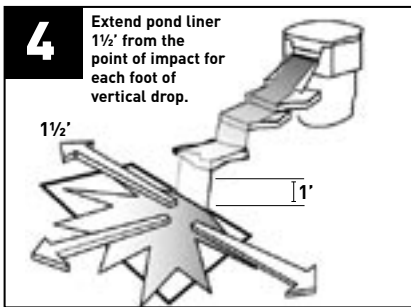

**4** To keep water in the system the liner must extend 1½' out on both sides, from the point of water impact for each foot vertical waterfall drop.



**5** Use rockwork and backfill to hide the liner and to blend the new water feature into surrounding landscape.



**6** Use SAVIO Black Foam™ to fill gaps in the rocks, preventing water from disappearing beneath and between them.

### TIP:

#### Streambed Depth

When a streambed becomes clogged with debris or ice, water may overflow the liner and drain the entire pond. To prevent overflow, provide enough depth to the waterfall and stream so water level is at least 6" below the top edge of the liner (the deeper the better). When the bed becomes clogged with debris and water backs-up, it will remain contained in the lined runway.

#### Streambed Length

When the pump is shut off the water in the streambed will settle into the lowest point in the pond. To prevent a sudden rise in water level from flooding, make the pond surface area at least twice that of the streambed surface area.

## PATCH THE LINER

Fixing a puncture in EPDM liner is easy. Use the self adhesive cover included with your kit and follow the instructions below.

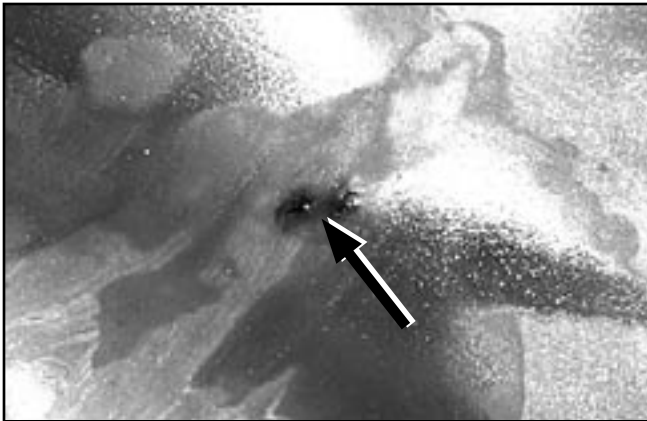

### Clean Hole

Clean area around puncture so that it is free of dirt and debris. Use an abrasive pad to roughen a 1" circular area around the hole.

### Cut Patch

Cut a round piece of patch from the self adhesive cover kit provided. Make the patch slightly smaller than the abraded area.



### Apply Patch

Apply PVC primer to abraded area and allow to dry. Then remove backing from patch and apply. Smooth the patch and press firmly for 30 seconds.



## ACCESSORIES

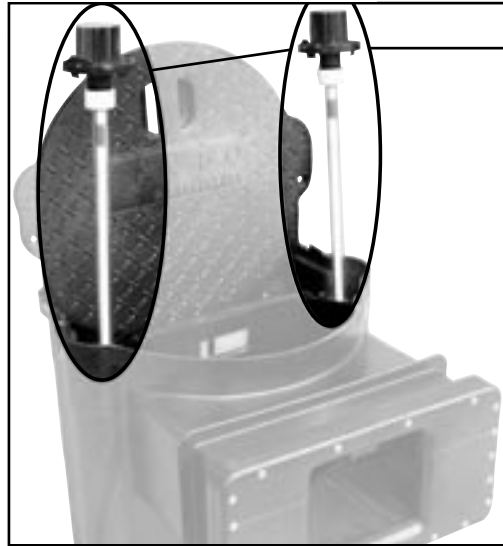

### **Ultraviolet Clarifiers**

The best way to clear green water. Aids in filtration and reduces the need for chemicals to control water clarity. Available in 25 & 57 watt. (part no. SUV025 & SUV057)

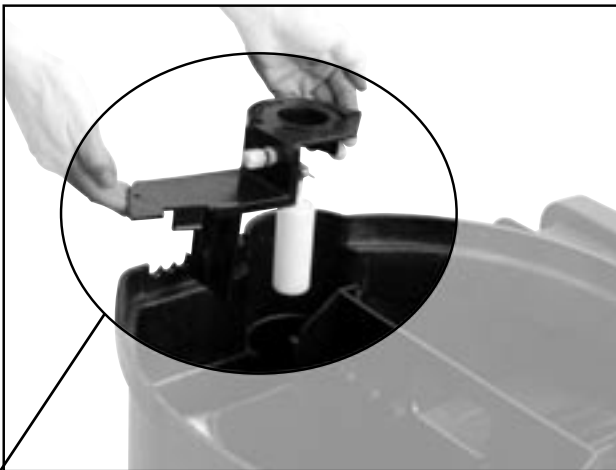

### **Mini Float Valve Kit**

Maintain your pond at its optimum level. For use in Savio Skimmerfilters™ where only one UV Clarifier is installed. Self tapping valve and 1/4" tubing included (part no. K1003)

### **Optional Mid-Water Intake Kit**

Draw water from below the pond surface with this optional Mid-Water Intake Kit for Savio Skimmerfilter.™ Can also be used to connect to a pond bottom drain. (part no. K1001)

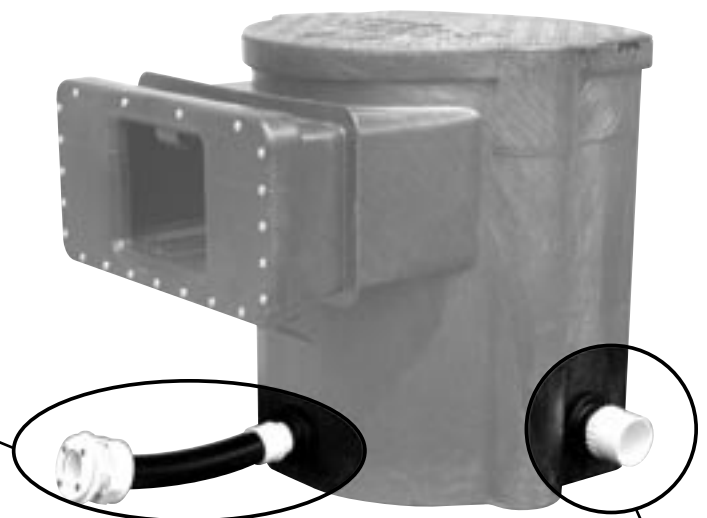

### **External Pump Kit**

Adapts an external pump for use with the Savio Skimmerfilter.™ Allows the pump to draw water from the central chamber through its outer housing and internal baffle. (part no. K1002)

## TROUBLESHOOTING

Use this troubleshooting guide to determine common problems and remedies. See component instructions for more information.

### SAVIO Skimmerfilter™

Problem	Possible Causes	Remedies
Pump chamber runs dry during operation.	Low water level in pond.  Weir door closed/stuck/obstructed  Weir not large enough for pump flow.	Add water to pond. Water level should be between ¼" above or below optimum water mark on faceplate.  Ensure free movement of weir door/ remove obstruction.  Reduce pump flow.  Install smaller pump.  Install larger weir assembly.
Water leak around faceplate.	Faceplate screws not tight.  Faceplate not sealed properly.	Use #3 phillips screwdriver to hand tighten screws snugly.  Remove weir face, clean liner of mud or gravel, smooth wrinkles. Reinstall.
Filter pad requires frequent cleaning.	Pump flow rate too high.  Heavy waste load in pond due to fish, or plant debris.	Adjust pump flow rate to 4,000 gallons or less.  Remove filter pad. Add a SAVIO Livingponds Filter.™
No debris collected by Skimmerfilter.™	Weir door closed/stuck/obstructed  Pump is not functioning.	Ensure free movement of weir door/remove obstruction.  Check operation of the pump and pump screen (if equipped).

### SAVIO Livingponds Waterfall Filter™

Problem	Possible Causes	Remedies
Water flows slowly from filter.	Pump is turned off or obstructed.  Feed line is obstructed.	Check pump operation. Remove any obstruction.  Remove obstruction.
Pond water will not clear.	Bacteria have not established.  Filter is too small for pond.  Filter media over-cleaned.  Pond is overstocked.	Add beneficial bacteria and wait 3-4 weeks.  Add another filter and/or a UV.  See maintenance section for proper care of media.  Reduce fish population or increase filtration.
Filter smells.	Filter needs cleaning.	Clean filter media. Add beneficial bacteria.

### SAVIO Waterfall Weir™

Problem	Possible Causes	Remedies
Waterfall Weir™ chamber runs dry during operation	Low water level in pond/Pump inactive.	Add water to pond/Restart pump.
Water flows slowly from Waterfall Weir.™	Pump is turned off or obstructed.  Feed line is obstructed.	Check pump operation. Remove any obstruction.  Remove obstruction.
Filter media smells.	Filter mat needs cleaning.	Clean filter media. Add beneficial bacteria.

### SAVIO Water Master Solids Handling Pumps™

Problem	Possible Causes	Remedies
No water flow from pump.	Pump is not plugged in.  No power from GCFI outlet  Pump is not priming.	Connect power plug.  Verify power supply to GCFI outlet  Verify pump inlet is submerged in water.
Low water flow from pump.	Debris blocking intake or impeller.  Flow control valve (not included) set too low.  Discharge pipe blocked.	Check intake and impeller for blockage and remove.  Check and adjust flow control.  Check and remove debris blocking discharge pipe.
Pump runs intermittently.	Thermal protection engaged.	Pump is too hot. Check that pump is fully submerged. Check inlet and discharge for clogs.

# SAVIO POND PACKAGES™

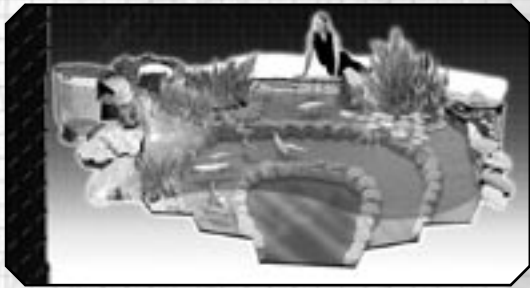

## PP800



Includes  
Waterfall Weir™

**8' x 11' x 2'**  
800 gal

## PP1500

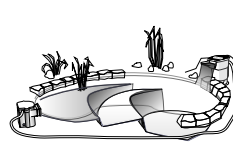

Includes  
Livingponds Filter™

**11' x 16' x 2'**  
1500 gal

## PP3000

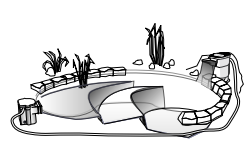

Includes  
Livingponds Filter™

**16' x 21' x 2'**  
3000 gal

### Equipment Provided

Savio Skimmerfilter™ Base Unit	●	●	●
Savio Livingponds Filter™		●	●
Savio Skimmerfilter™ Faceplate Assembly	6"	8.5"	8.5"
Savio Waterfall Weir™	●		
45 mil. EPDM Liner	12' x 15'	15' x 20'	20' x 25'
Underlayment	10' x 18'	10' x 30'	10' x 50'
Savio Water Master Solids Handling Pump™	1450 gph	2040 gph	3600 gph
Kink Free Hose™	1" x 25'	1.5" x 25'	2" x 25'
Savio Black Foam™ 13.5 oz.	●	●	●
Design & Construction Video VHS	●	●	●
Savio Natural Beneficial Bacteria™	●	●	●
Savio Natural Barley Extract™	●	●	●
Joint Cover	●	●	●
Plumbing Kit	●	●	●
Drain kit for Livingponds Filter™		●	●

### Tools Needed for Easy Installation

- |  |  |
|--|--|
| <input type="checkbox"/> shovel  | <input type="checkbox"/> wheelbarrow               |
| <input type="checkbox"/> 4' hand level                                     | <input type="checkbox"/> #3 phillips screwdriver   |
| <input type="checkbox"/> utility knife                                     | <input type="checkbox"/> large channel-lock wrench |
| <input type="checkbox"/> string level, site or transit level (recommended) |  |

### Rock To Secure Pond Edging

- 8' x 11' pond = 1-1/4 tons     11' x 14' = 1-1/2 tons     16' x 21' = 2-1/4 tons

Rock is usually sold by weight. Determining the amount of rock needed for pond edging can be highly variable depending upon the thickness and size of rocks to be used. Amounts given above are a general guideline and are based on rocks with average dimensions of 7.5" x 7.5" x 7.5".

**Your Pond  
Dealer**



**\$3.95**

