

SECTION A-A

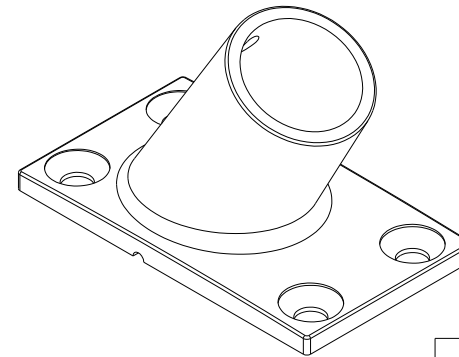

Whitecap

Units	INCHES	View	
P/N	6142		20161230