



## Zenport EP27 Cordless ePruner

### User's Manual



**Note: Please read this manual carefully before using the tool.**

## Contents

Zenport EP27 Cordless ePruner.....	1
Contents.....	2
Safety Precautions .....	4
Symbols Defined .....	4
The Symbols in the Manual .....	4
The Symbols on the Battery .....	4
The Symbols on the Charger.....	5
General Power Tool Safety Instructions.....	5
Work Area Safety .....	5
Electrical Safety.....	5
Bodily Safety.....	6
Power Tool Use Safety.....	6
Battery-Operated Tool Precautions .....	7
Special Safety Instructions .....	7
Other Safety Instructions .....	8
Special Safety Instructions for Battery-Powered Tools .....	8
Other Risks.....	9
Intended Use.....	9
Description of Functions.....	9
Product Overview.....	10
Parts List .....	10
Display .....	11
Technical Parameters .....	12
Included Items.....	13
Charging the Battery .....	13
Working Conditions .....	14
Proper Use of the Battery Charger .....	14
Assembly.....	15
Operating Instructions .....	15
Trimming Tips .....	16
Cleaning and Maintenance .....	17
Cleaning .....	17

Disassembly and Assembly Maintenance Steps .....	17
Tool Calibration .....	21
Calibration Steps .....	21
Sharpening .....	22
Pruner Storage .....	22
Waste Disposal and Environmental Protection .....	23
Spare parts.....	23
Troubleshooting .....	24
Warranty.....	25
Warranty Terms.....	25
Warranty Validity Period .....	25
Warranty Validity Period Calculation .....	25
Warranty Range of Coverage.....	26
Not Covered Under Warranty .....	26

## Safety Precautions

In order to ensure your safety and the safety of others, please read this manual carefully before using your Zenport ePruner for the first time. Keep this manual in a safe place. If changes are made, be sure to check the updated contents. If ownership of your ePruner changes, please forward this manual to the new owner.

## Symbols Defined

This section details the basic safety symbols on the machine.

### The Symbols in the Manual



**Warning:** Use extreme caution to prevent damage or injury.



**Instruction:** Steps to prevent damage and safety.



**Help:** Information to help improve the handling of the tool.



**Read Carefully:** Pay extra attention to manual contents.



**Gloves:** Please wear gloves to help protect hand and fingers from injury.



**Eye/Ear Protection:** Wear ear and eye protection.



**Moisture:** Do not operate in the rain or on wet hedges or branches.



**Disposal:** Please do not dispose the batteries in your household trash. Please take old or used batteries to your local recycling station.

### The Symbols on the Battery



Do not discard lithium-ion batteries with household trash



Do not dispose the battery in fire. It may explode.



Do not store battery in water or wet environment as it will damage the battery and may explode.



Do not expose the battery to direct sunlight or hot surfaces as it will shorten the battery lifespan and may explode. (Max temperature 140F/60C)



Recycle the battery and do not dispose batteries in your household trash. Please take old or used batteries to your local recycling station.

## The Symbols on the Charger



Warning! Use extreme caution to prevent damage or injury.



Please read before operating



Indoor use only



Temperature Protection



Class II Device



Disposal: Please do not dispose of batteries in your household trash. Please take old or used batteries to your local recycling station

## General Power Tool Safety Instructions



### Warning!

- 1) Read all safety directions and instructions. Failure to follow the warnings and instructions below may result in electric shock, fire, and/or serious injury.
- 2) Keep all safety directions and instructions for future reference.
- 3) In all the following warning terms, "power tool" refers to an electrically driven (wired) power tool or a battery powered (wireless) power tool.

## Work Area Safety

- 1) Keep the work area clean and bright. Poor visibility can cause accidents.
- 2) Do not operate the power tool in a hazardous environment, such as in areas with flammable liquid, gas or dust. Sparks from power tools ignite dust or gas.
- 3) Operate the power tool without any distractions. Inattention can cause the operator to lose control of the tool.

## Electrical Safety

- 1) Always make sure that tool plug matches the socket. Never modify the plug in any way. If the plug is difficult to place inside of the socket, double check the alignment of the plug key and plug type. Unmodified plugs and matching outlets will reduce the risk of electric shock.
- 2) Do not use any ungrounded AC adapter plugs with grounded power tools.
- 3) Avoid bodily contact with grounded surfaces such as pipes, radiators, ranges and refrigerators. If your body is grounded, it will increase the risk of electric shock.
- 4) Do not expose the power tool to rain or wet conditions. Water entering the power tool will increase the risk of electric shock.
- 5) Do not misuse the cord.

- Never use the cord to carry, pull or unplug the power tool. Keep the cord away from heat, oil, sharp edges, or moving parts.
  - Damaged or entangled cords increase the risk of electric shock.
  - Threading the power cord through a picking sleeve will prevent the cord tangling or getting cut.
- 6) When using power tools outdoors, use an outdoor external cord. A cord suitable for outdoor use will reduce the risk of electric shock.
  - 7) If charging the tool in a damp location is unavoidable, use a residual current device (RCD) protected supply. Use of an RCD reduces the risk of electric shock.

## Bodily Safety

- 1) Be awake, alert and pay close attention during the operation of power tools. Do not operate the power tool when you are tired, intoxicated or on medication. Falling asleep or losing consciousness during in the operation of the power tool can result in serious personal injury.
- 2) Use personal protective equipment. Always wear goggles and safety equipment such as dust masks, non-slip safety shoes, hard hats, hearing protection, etc. Wearing safety gear in appropriate conditions can reduce personal injury.
- 3) To prevent accidental start-up, make sure the switch is in the off position when connecting the power supply, battery, picking up or carrying the tool. Inserting the plug when the tool is plugged in or when it is turned on can be dangerous.
- 4) Remove all adjustment keys or wrenches before the power tool is turned on. A wrench or key left on the moving parts of the power tool can cause personal injury.
- 5) Do not overextend your reach and lose balance. Always pay attention to your foothold and body balance. This allows for good control of the power tool especially during unexpected situations.
- 6) Dress properly. Do not wear loose clothing or jewelry. Keep clothing, gloves and hair away from moving parts. Wearing loose clothes, accessories, or long hair may get caught in moving parts.
- 7) If you are providing equipment for connection with chip evacuation and dust collection equipment, make sure they are connected and used properly. Use these devices to reduce the risk of dust.

## Power Tool Use Safety

- 1) Do not overload tool by using it outside the designed operation specifications. Choosing the right power tool will make your work more efficient and much safer.
- 2) Do not attempt to use tool if any of the switches are not working properly. Power tools that cannot be controlled with switches are dangerous and must be repaired.
- 3) Unplug your power tool from the power supply and/or the battery before any adjustments, cleaning, maintenance, replacement of accessories or in preparation of storage. This protective measure will reduce the risk of accidental start-up of the tool.
- 4) Store unused power tools outside the reach of children.

- 5) Do not allow power tools to be operated by people unfamiliar with power tools or these instructions. Power tools are dangerous in the hands of untrained users.
- 6) Power tool maintenance: check that the moving parts are in place and not stuck. Check for damage of the parts and other conditions that affect the operation of the power tool. In case of damage, the power tool should be repaired before use. Many accidents are caused by poorly maintained power tools.
- 7) Keep the moving cutting and non-moving blades sharp and clean. Well-maintained tools with sharp cutting edges are less likely to get stuck and are easy to control.
- 8) Use power tool, accessories and working surfaces in accordance with the operating instructions and work conditions. Using power tools for operations that do not match their purpose can be dangerous.

### Battery-Operated Tool Precautions

- 1) Make sure the switch is off before inserting the battery pack into your ePruner. Inserting the battery into a power tool whose switch status is ON can cause an accident or damage to the tool.
- 2) Charge only with the charger provided by the manufacturer. There is a danger of damage to the battery and fire when using an unsuitable charger..
- 3) Use only battery packs designed and provided by the manufacturer. Damage to the tool and fire hazards can occur when using non approved battery packs or power sources.
- 4) When the battery pack is not in use, being transported, or stored away, make sure that no small metal objects, such as paper clips, coins, keys, nails, screws, can meet the battery terminals. If the positive and negative terminals are connected a short circuit will occur causing a fire or explosion.
- 5) When used inappropriately, liquid and fumes may escape out of the battery so one must avoid contact. If you accidentally come in contact, rinse with water. If liquid or fumes make contact with your eyes, seek medical help. Liquid and fumes that can escape from the battery can corrode or burn.

### Special Safety Instructions

- 1) Keep the tool at least 16-inches away from any part of the body.
- 2) Do not remove cuttings while the blade is in operation.
- 3) Do not hold the objects you intend to cut with your opposing hand..
- 4) Only remove cuttings when the power is off.
- 5) When using the pruning shears, a slight oversight may result in serious personal injury.
- 6) When the blade is stopped, only carry the pruner by the handle and never by the cutting blades.
- 7) Careful and correct use of pruner will reduce the risk of injury from the blade.

## Other Safety Instructions

- 1) For personal safety, wear suitable gear such as non-slip boots and protective trousers, gloves and goggles.
- 2) Do not wear loose, lengthy clothing and jewelry to avoid getting caught in moving parts.
- 3) Do not use this tool with bare feet or slippers.
- 4) Do not use this pruning shear in heavy rain or near strong magnetic fields.
- 5) This product is designed to trim hedges and branches. Do not use for cutting petrified wood, rocks, wire, nails and other items.
- 6) Do not attempt to dislodge a jammed blade until the power is turned off.
- 7) Before starting to trim, check the hidden items in the hedge and branches, such as wires, nails, etc.
- 8) When using this product, always hold the tool with one hand and keep your opposing hand at least 6-inches away including all other parts of the body.
- 9) Do not use this tool near flammable liquids or gases. If a short circuit occurs, it may cause an explosion or fire.
- 10) The blade must be inspected regularly and sharpened. A dull blade will overload the machine. Warranty does not cover damage from dull blades.
- 11) Unless you have received training, please do not repair your ePruner yourself. Repairs not mentioned in this manual can only be performed by trained personnel in our service center. If you do your own repair work this will void your warranty.

## Special Safety Instructions for Battery-Powered Tools

- 1) Make sure the battery switch is off before inserting the battery. Inserting the battery without turning it off may result in damage to the device.
- 2) The battery charger is designed for indoor use, it is necessary to ensure that the battery is only charged indoors.
- 3) Before cleaning the charger, please unplug the charger from the AC outlet and from the battery pack to reduce the safety risk.
- 4) Do not leave the battery under direct sunlight for a long time. Do not place the battery on the heater. Heat can damage the battery and there is a danger of explosion.
- 5) Before charging, please ensure that the high temperature battery is fully cooled.
- 6) Do not open the battery to avoid any mechanical damage. It may cause a short circuit or emit a gas that is harmful to the respiratory tract. In case of discomfort, inhale fresh air and seek medical advice.
- 7) Do not use a non-rechargeable battery or any other power source not approved by the manufacturer.



## Other Risks

Even with the correct use of this power tool, some risks will still exist. Due to its structural characteristics, this power tool may have some hidden dangers:

- 1) Cuts
- 2) Cause hearing damage when the ear guard is not worn
- 3) Damage to the user's body due to prolonged or unreasonable operation of the device by hand



### **Warning!**

When in use, the electric pruner will generate an electromagnetic field. In certain circumstances, this magnetic field can damage the function of an implanted medical device. To avoid serious injury, we recommend users who have implanted medical devices, to consult a doctor and the manufacturer of the medical implant device before using this product.



**Do not touch the blade while the ePruner is on to avoid personal injury.**

## Intended Use

This device can be used for trimming hedges, shrubs, vines and branches. If this product is used for other non-plant material pruning purposes, it may cause damage to the equipment and cause harm to the user.

This device can only be used by adults. Minors over the age of 16 can use the device under the supervision of an adult. Do not use the device on rainy days or on wet plant material. The operator or user assumes full responsibility for any accidents during use, injury to others or loss of property to others.

The manufacturer is not responsible for damage caused by unconventional or improper use. Before using, please check if the blade is sharp. If the blade is blunt, be sure to sharpen the blade to prevent the machine from being loaded. Damage due to the use of blunt blades is not included in quality assurance.

## Description of Functions

This cordless battery powered electric garden pruning shear cutting blades are made of special grade SK5 Japanese steel and is a strong and powerful tool. Light weight for easy one-handed operation. This product combines safety, efficiency, and ease of operation.

When used, the cuttings are even and smooth causing no damage to the plants. If an abnormality occurs, simply release the trigger and the blade will open in the maximum position to avoid personal injury or property damage.

## Product Overview

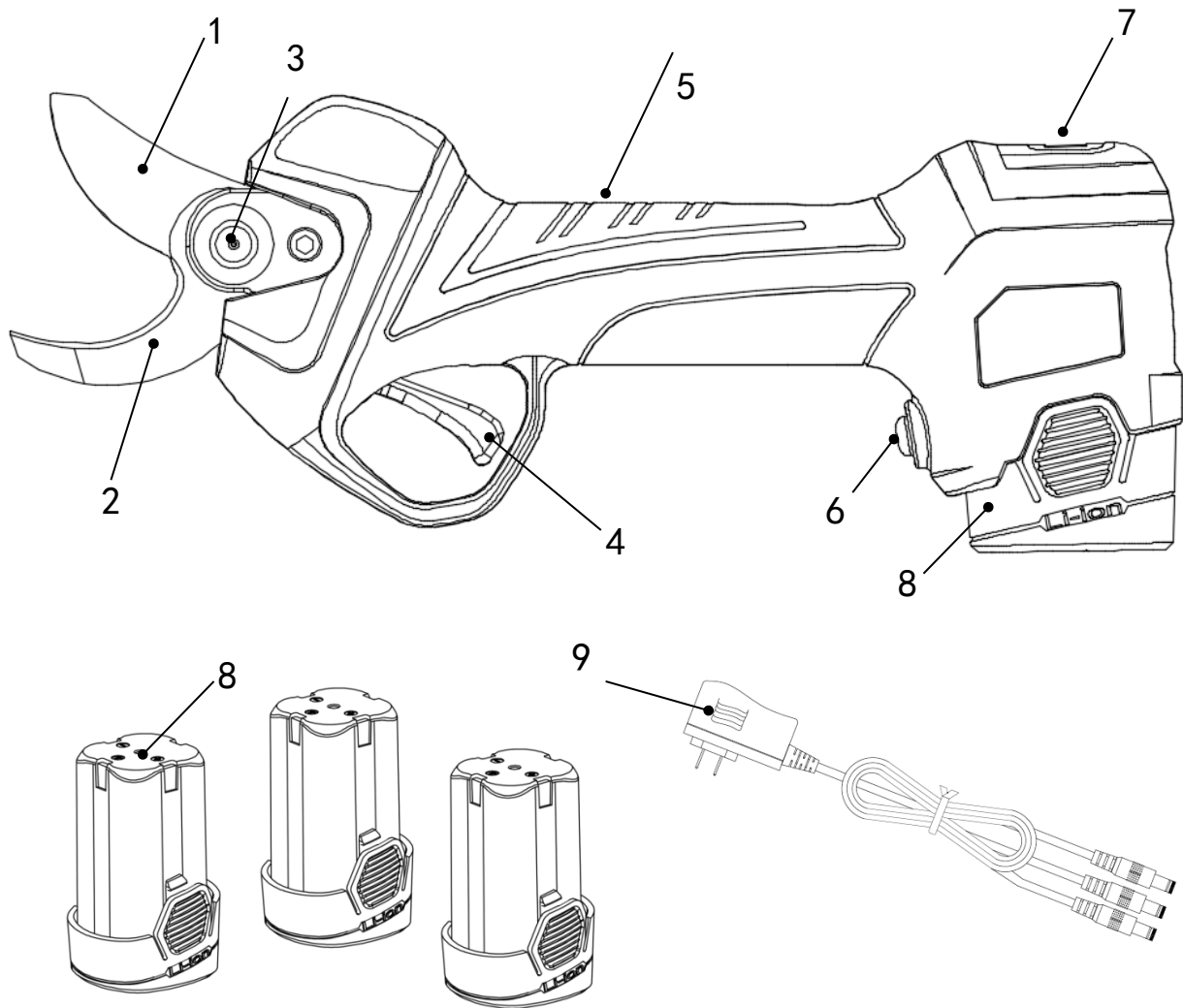

## Parts List

- 1) Cutting blade
- 2) Fixed blade
- 3) Blade fixing mechanism
- 4) Trigger
- 5) Grip
- 6) Switch
- 7) Display
- 8) Battery
- 9) Charger

## Display

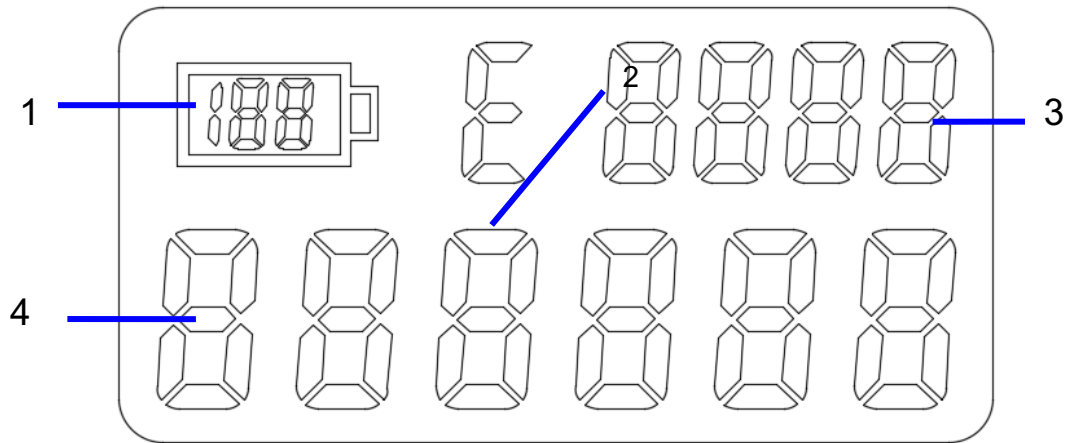

Display description				
No.	Description	Type	Function	Type of display
1	Battery		The battery capacity in percentage	1-100
2	Fault Indicator	 	<ol style="list-style-type: none"> <li>The electronic control system is normal when C is displayed.</li> <li>Failure of electronic control system when displaying E.</li> </ol>	 
3	Number of cuts per session		The number of cuts per pruning session.	
4	Number of cuts per lifetime		Recommend maintenance after the number of cuts reach nearly 500,000.	

When the fault indicator displays E. the numbers of cuts in total will be display with the following code

Code displays	Means
1	Software overflows
2	
3	Hardware current sampling fault
4	Blocked
5	Undervoltage
6	Overvoltage
7	Overcurrent
8	
9	Low battery
10	Motor open phase
11	Hall signal failure

Technical Parameters		
<b>Pruning Shears</b>		
1	Maximum Shear	35mm (live branches) 30mm (dead branches)
2	Rated Voltage	DC14.4V
3	Rated Power	150 W
4	Rated Current	10.0 A
5	Current Protection Stop Point	≥45A
6	Protection Level	II
7	Weight	0.9Kg
<b>lithium-ion Battery (3 batteries included)</b>		
1	Capacity	2.5 Ah
2	Voltage	14.4V
3	Operating Hours	2-3 h
4	Weight (battery)	0.25kg
<b>Charger</b>		
1	Rated Voltage	100-240V AC ,50-60Hz
2	The Output Voltage	DC16.8V
3	Recharging Current	1.0A
4	Protection Level	II
5	Charging Time	2h

## Included Items

Please carefully open the package and check that the parts are complete:

- Electric Pruning Shears
- Battery x 3
- Charger
- Toolbox
- Instruction Manual
- Warranty Card

## Charging the Battery



Do not expose the battery to extreme conditions such as high temperatures or shocks. Otherwise, personal injury will result from leakage of the electrolytic solution.



Before charging, check that the battery surface is clean and dry.

- The battery of this product is fully charged before delivery. Therefore, it must be fully charged before first use.
- Charge the battery when the power indicator light is lit.
- Do not charge the battery for a long time, and avoid using all the power in the battery, otherwise the battery will be damaged. This quality assurance does not cover failures due to improper use.
- If the battery life of the fully charged battery is significantly shorter, it proves that the battery has been used up and must be replaced. Users can only use the original equipment-built (OEM) battery packs provided by the Customer Center.
- Always keep in mind the applicable safety instructions, environmental regulations and environmental information.
- Place the charger in a room between 50°F and 72°F at room temperature to prevent moisture ingress.
- Check if the switch is in the off position.
- Connect the charger's adapter to the appropriate connector of the battery pack.
- Make sure the power supply matches the rating on the charger and adapter.
- When the red light on the charger is on, it indicates that the battery is charging, and the green light indicates that charging is complete. The average charging time is 2-3 hours.
- When charging is complete, unplug the connector from the power source and disconnect the connector from the battery.
- Please ensure that the battery is charged at least once every three months when the battery is not in use for a long time.



When charging the battery, the pruning shears must be disconnected.

## Working Conditions

- 1.) Keep the charging temperature of the charger and battery pack between 32° F ~ 113°F, and the battery pack discharge temperature between 14°F ~ 140°F.
- 2.) The working temperature of the pruning shears 23°F ~ 86°F

## Proper Use of the Battery Charger

- 1) Only use the supplied charger to charge the battery. Failure to do so may result in fire or explosion. Use the matching charger to ensure the safety of the device.
- 2) Check the charger, cord and plug before each use. If it is damaged, please have it repaired by qualified personnel and use original parts. Do not use a defective charger and turn it on yourself to ensure the safety of the device.
- 3) The link socket of the charger must be grounded. Make sure that the power supply voltage matches the rating of the nameplate on the charger. Otherwise, there may be an electric shock.
- 4) Disconnect the charger from the power source before closing or opening the connection to the battery/power tool/device.
- 5) Keep the charger clean and away from humid environments and rain. Do not use the charger outdoors. The ingress of dirt or moisture will increase the risk of electric shock.
- 6) The charger can only be used to charge the original battery. If it is charged for other batteries, it may cause personal injury and cause fire.
- 7) Avoid mechanical damage to the charger. Otherwise, it may cause an internal short circuit.
- 8) Do not use the charger (e.g., paper, textiles) on the surface of flammable materials.
- 9) If the equipment is damaged, it must be replaced by the manufacturer, customer service personnel or personnel with the same or similar qualifications to prevent danger.
- 10) At the time of delivery, the battery of this product is not fully charged. Therefore, the user must fully charge it before using it for the first time. For the first charge cycle, we recommend that the user charge for 2-3 hours. Insert the battery into the base and plug the charger into the power outlet.
- 11) After the battery is fully charged, unplug the charger from the power supply and the device.
- 12) Charging time is about 2 hours after the battery is completely discharged. Do not charge the battery for an extended period as this will damage the battery.

## Assembly

Please check that the pruning shears, wires and batteries are clean and dry, and then follow the steps below to assemble:

- 1) Place the battery pack in the battery compartment, securing the battery after you hear a click. Make sure that the connector is facing right if you are right-handed. Check the opening and closing position of the pruning shears
- 2) Grip the handle with your hands
- 3) Turn on the power switch, pull two scissors to the trigger in a row and open the scissor head. You can start the operation.

## Operating Instructions



When using this device, wear suitable clothing and work gloves. The risk of injury can be reduced by wearing a protective device and ensuring that the device is functioning properly.



Make sure the device is functioning properly before each use. The start/off switch and safety switch must be in working use. If the switch is loose, the power must be turned off. If the switch is damaged, stop using the device.



Ensure that the voltage of the power supply is consistent with the voltage on the device nameplate.



Make sure the scissors work properly to ensure that the electric scissors work in an optimal state.



When the device is turned off, the blade will continue to run for some time. Wait for the blade to stop. Do not touch or block moving blades. Otherwise, it will cause danger!

- 1) Turn on the power switch, and after hearing the prompt tone, pull the switch twice continuously within 1 second. After hearing the prompt tone again, the pruning shear is in a working state, and the trigger can be started.
- 2) If the pruners stop working during long term use and you hear 4 fast beeps, this is an indication of undervoltage protection which means the battery is depleted. Please charge as soon as possible.
- 3) In order to conserve the use of battery power and ensure that the pruning shears have the longest service life, do not overload the device and prohibit it from being used for cutting more than 35mm wet branches and .30 dry branches.
- 4) During the shearing process, if the shearing knife encounters a branch that cannot be cut off, then release the trigger to be reset to the opening position, after which the next normal shear session can be carried out.



The blades of the pruner should not be moved around during while cutting, so as not to damage the blades. Never move the pruner side to side when wedged.

In order to save the use of battery power and ensure the longest service life of pruning shears, do not overload the device and do not use it for cutting more than 25mm (1-inch) wet branches and 15mm (.6-inch) dry branches.

If the cutter encounters a branch that cannot be cut during shearing, release the trigger, shears will return to the opening position, after which the next normal work can be performed.

Note: The ePruner should not be twisted from side to side in the pruning process, so as not to damage the blade..

## Trimming Tips

- When the device is running, please keep your other hand at least 6-inches away from the cutting area of the blade, and the hand should not be placed in the blade.
- Cannot use this device to forcibly cut larger branches, otherwise it may deform the blade, causing the pruning shears to get stuck. Do not tilt and move when trimming branches.
- If the user does not follow the instructions, it may pose a danger. In cold or wet weather, in order to protect the battery pack, please place it under waterproof clothing, please do not use this device on rainy days.
- We recommend that after daily use, you must cut off the connection between the pruning shears and the battery pack, turn off the power switch, and put them together in the companion toolbox.
- If the user feels that there is not enough power, or if the cut is not smooth enough, check to see if the charge is depleted or if the blade is dull.
- Cleaning and maintenance of repair work functions not mentioned in this manual shall be carried out by the service center.
- To ensure safe use, only original parts can be used. Please turn off the device before you begin the overhaul.
- Please cut off the connection between the battery and the device and store the battery in a safe package. Wear gloves when touching a safety blade. This prevents sharp blades from scratching the user. Subsequent cleanup and overhauls must be carried out on a regular basis. This ensures the long-term reliable operation of the equipment.



## Cleaning and Maintenance

### Cleaning

- Do not spray the equipment with water or immerse it in water, otherwise it may cause electric shock and damage to the pruner.
- Keep the handle of the ventilation tank, engine room and equipment clean.
- Clean with a damp cloth or brush.
- Do not use detergents.
- Please clean the blade carefully after each use.
- Wipe the blade with an oily cloth.
- After 8 hours of continuous operation, please disassemble the front cover of the equipment to clean the wood chips and other impurities.

### Disassembly and Assembly Maintenance Steps

General maintenance, cleaning, lubrication and blade replacement requires some disassembly and assembly of your ePruner.

The cover is fastened to the pruner by 4 screws. The center bolt is secured with an adjustable gear nut which is locked into place by a gear nut clip. The gear nut clip is secured by a single bolt.

With the removal of the of the cover, adjustment clip, gear nut, and center bolt you can access, maintain, clean, lubricate and replacement of blades when necessary.





**2. Remove the nut counterclockwise as shown in the diagram and remove the flat needle roller bearing.**

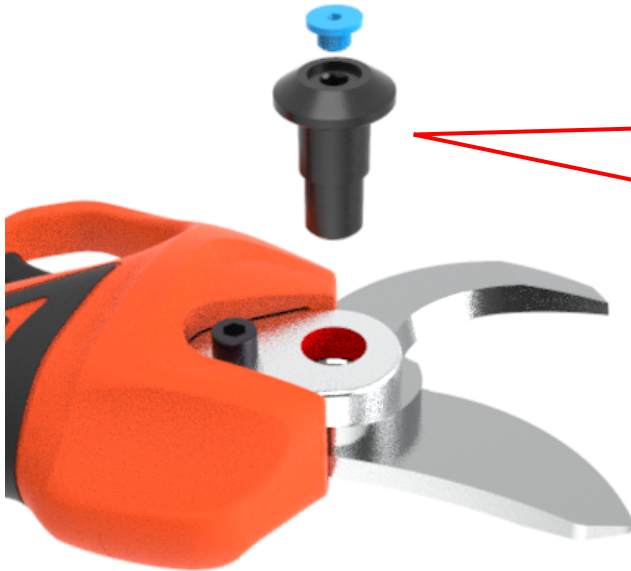

**3. Remove the rubber cover and turn counterclockwise to remove the hexagon socket bolt.**



**4. Rotate counterclockwise as shown in the diagram and remove the M3 screw from the blade cover.**

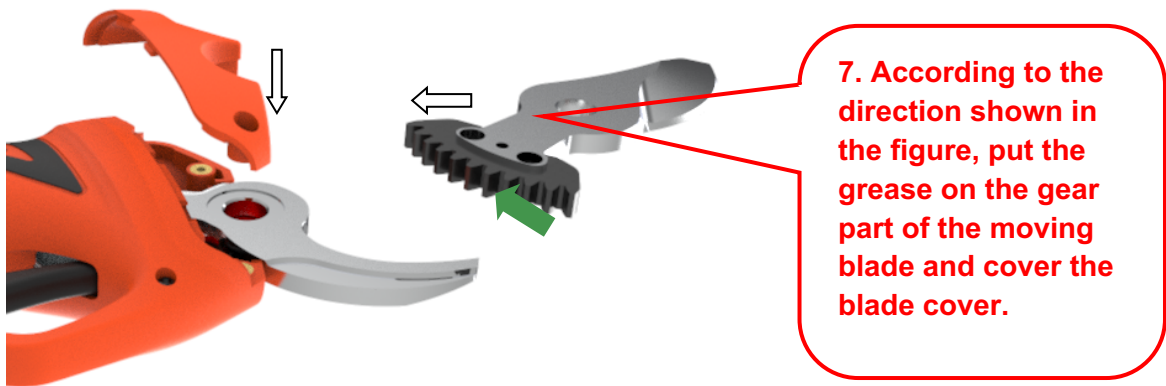
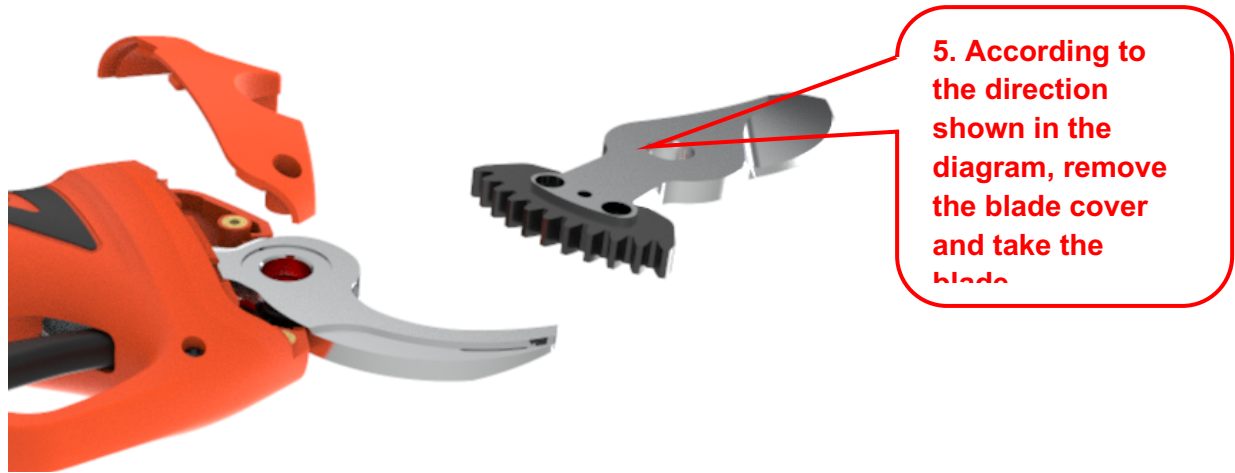

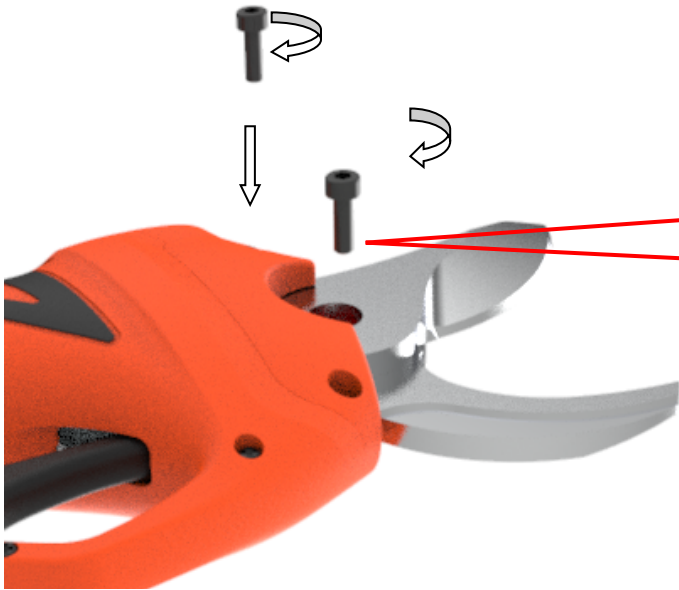

**8. Screw the M3 hexagon socket screw as shown in the drawing.**

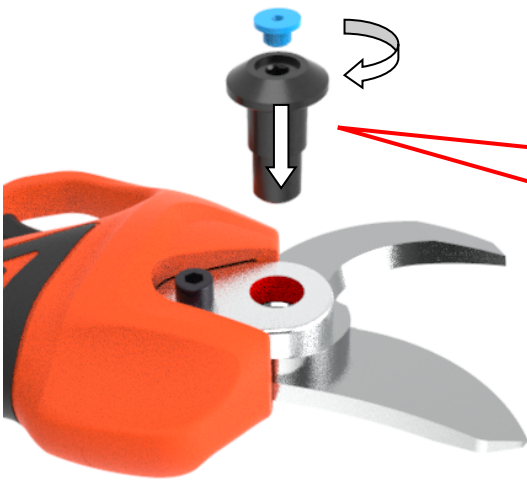

**9. Twist the inner hexagon blade screw clockwise as shown in the picture. Press in the plastic cap**



**10. Place the flat needle roller bearing as shown in the drawing and screw on the locking nut.**



**11. Screw the M5 hexagon socket countersunk head counterclockwise as shown.**



**12. Lubricate properly to reduce the friction between the two blade from the hole in the plastic cap as shown in the figure before work.**

## Tool Calibration

If a repair replacement motor or drive plate is required, the pruners need to be recalibrated.

### Calibration Steps

- 1) Remove the upper and lower blades.
- 2) Insert the battery.
- 3) Hold down the trigger and remain motionless. Press the POWER switch again.
- 4) The trigger remains motionless for more than 20 seconds.
- 5) Release the trigger when you hear the motor turning.
- 6) The electric motor rotates during calibration. When the motor stops turning the calibration is complete.

## Sharpening

This step is critical because it determines the trimming quality, life of the blade and battery life. The harder it is to cut, the more power your ePruner uses.

- When you notice the cuts are slower or when you feel more resistance, check the blade and sharpen the edge.
- The frequency of the sharpening tip depends on the properties of the shearing wood (hardness and diameter), the pruning rate and the sharpened edge of the blade (special sharpening stone and oil are provided).
- In the early stages of use, to get a feel for how often you will need to sharpen the blades, check the blade edge every 15 minutes.
- Adjust cutting and counter blade clearance in order to ensure that the cut is clean and accurate. The gap between the blades should be adjusted regularly as the friction will wear the blades where they contact. The gear nut is designed in a way where you can lock its position with a clip allowing regular adjustments as needed.
- To adjust the blade to the appropriate clearance of about 0.03mm. Remove the gear nut clip, rotate the gear nut clockwise. When adjustment is completed lock the gear nut in place with the gear nut clip.

## Pruner Storage

**The most important thing to keep in mind before storing your ePruner's lithium-ion batteries, is to make sure that the batteries are fully charged up and the power switch off.**

Storing your battery pack for long extended periods of time with little or no charge will damage your battery and void your warranty.

- 1) Ensure that the battery is fully charged.
- 2) Make sure that the battery pack is switched off.
- 3) Avoid storing the device in extremely hot or cold environments.
- 4) If the device will not be used for a long time, disconnect the battery before storing it.
- 5) Batteries and chargers must be placed in a secure location prevent heat, dust and moisture from entering and check that the switch is off.
- 6) Batteries should be stored in a dry environment.

### Suggested Storage Temperatures:

Short-Term (less than one month)	-20°F ~ +60°F
Medium-term (less than six months)	+10°F ~ +35°F
Long-Term (more than six months)	+0°F ~ +30°F

- 7) The battery and flammable matter must be kept at least 5-feet apart.

- 8) In order to ensure the service life of the equipment and to prevent its degradation, it must be stored with enough battery power.
- 9) When not in use, charge the battery at least once a month.
- 10) Do not turn on the power switch while storing.



Note: Pruners that have cut over two years, require comprehensive inspection and maintenance. Please contact the local dealer

## Waste Disposal and Environmental Protection

Remove the battery from the device and recycle the equipment, batteries, accessories and packaging in an environmentally friendly manner.

The device is not to be discarded with common household waste. The equipment is sent out of the recycling center. Metals and plastics in the device can be recycled after they have been filtered.

- Do not dispose the battery with household waste, fire (danger of explosion) or water.
- If toxic gases or liquids leak, damaged batteries can pose a risk to the environment and the health of the user
- Discharge all the power in the battery before disposing.
- Use tape or glue any battery openings to prevent short circuits.
- Do not dispose the battery turned on.
- Discard the battery according to local regulations.
- Send the battery to the battery recovery point for environmentally friendly recycling.
- Please consult your local waste management company or our service center.

## Spare parts

If additional spare parts are required, please use the original product and we can provide you with high quality components.

- 1) Battery pack
- 2) Battery charger
- 3) Blades

## Troubleshooting

<b>Problem</b>	<b>Possible Reason</b>	<b>Corrective Action</b>
<b>ePruner Will Not Start</b>	Battery dead	Charge Battery
	Battery not connected	Connect battery
	Safety switch cannot be initiated	Open by initiating safety on switch
	On / off switch failure	Send to repair service center
<b>Intermittent Operation</b>	Loose internal connections	Send to repair service center
	On / off switch failure	
<b>Hot Blades</b>	Blade dull	Sharpen or replace the blade
	Blade gap	Sharpen or replace the blade
	Poor lubrication, resulting in excessive friction	Lubricate blade
<b>Poor Trimming Performance</b>	Lubrication is not in place, resulting in excessive friction	Lubricate blade
	Dirty blade	Clean blade
	Blade dull	Sharpen or replace the blade
	Trimming technique is poor	Read the instructions carefully
	The battery is not fully charged	Charge the battery
<b>Will not charge. Charger red light flashes.</b>	The battery is not properly placed in the charger	Insert the battery correctly
	The battery charger is not connected properly to the power supply	Connect properly
	Battery contact point is dirty	Clean
	Invalid battery	Replace battery
	Battery charger is invalid	Replace Battery Charger



## Warranty

### Warranty Terms

The product warranty period: one year for electrical and three months for mechanical.

These terms apply except under the following conditions:

- Any natural wear and tear or trying to use the tool outside of design specifications.
- Damaged by lack of routine maintenance and maintenance.
- Improper use and other damage due to human error.
- Damage caused by improper transportation after sale.
- Parts are modified and repaired by illegal maintenance personnel.
- Unavoidable factors such as natural disasters (fires, lightning, floods, etc.).
- Severe impact damage.
- Use of non-original accessories and batteries.
- In order to avoid unnecessary disputes, please note: If the tool is not repaired or replaced during the warranty period, we will charge the appropriate fee.

### Warranty Validity Period

**The whole machine (main components such as lithium battery): 12 months.**

### Warranty Validity Period Calculation

The warranty period is valid from the date on which the buyer takes possession and title of the pruner.

During the validity period of warranty if the product is faulty, the user should contact Zenport for instructions.

## Warranty Range of Coverage

- 1) During the warranty validity period, only when the product is used correctly according to the product designed specifications. There are formal purchase invoices and warranty vouchers. The entire machine and main components are covered under the warranty.
- 2) For products that have been purchased and are still in the warranty validity period, users can continue to enjoy the warranty service with the original purchase invoice of the product and the warranty certificate.
- 3) The loss of purchase invoices and warranty certificate but can prove that the products purchased in the warranty of the validity period, still enjoy the warranty of services.

## Not Covered Under Warranty

- 1) Easily damaged parts such as the cutting blades or trigger guard housing.
- 2) Damage due to improper use or maintenance caused by the early wear and failure of parts.
- 3) Failure caused by self-modification and disassembly
- 4) No valid purchase invoice and warranty voucher. Inability to prove that the products were purchased within the warranty validity period.
- 5) Based on the valid purchase invoice and warranty voucher, the product specifications, models and requirements do not match or are altered. However, if due to the fault of the seller, the purchase invoice or warranty voucher on the agricultural machinery product brand, model and other requirements do not match, the seller may not refuse to fulfill the warranty regulations.
- 6) After failure, the user did not maintain the original damage or, without the consent of the seller/repairman, the product was disposed of in part or in whole so that the cause of the failure cannot be technically identified (except in the case of response processing time).
- 7) Counterfeit products not produced by the company and damage caused by unavoidable forces.